

VR2W USER MANUAL



*Requires the use of the
latest VUE software*



www.vemco.com

28 July 2018 DOC-4400-22



IMPORTANT SAFETY INFORMATION

At VEMCO, we make every effort to ensure all of our products are as safe as possible. However, some hazards are unavoidable when deploying equipment underwater.



IMPORTANT

Throughout this document, **read all warnings and cautions** before proceeding with next steps in procedures and using the product.

Your safety is important to us, so please read this list of cautions carefully, and follow the directions below.

Case Pressurization

If a case leaks underwater, the inside pressure will increase to match the pressure at that depth. This extra pressure will release as the unit is brought to the surface; however, if the leak is small, that pressure release will be very slow. This will result in the case still being highly pressurized at the surface.

Such a case can fly apart with explosive energy and represents a serious safety hazard.

Battery Breach

Lithium batteries contain chemicals that represent a serious health hazard – particularly when combined with water.

Most VEMCO receivers and acoustic releases use this type of battery. A battery breach can occur if a VEMCO receiver or acoustic release becomes damaged and water gets into the internals.

In addition, the reaction of the released chemicals with water in the sealed case can lead to case pressurization, which could be explosive.

Safety Features

VEMCO receivers and acoustic releases that are designed to be deployed at depth may be equipped with a pressure release that will activate when internal pressure reaches a certain level above external pressure. This mechanism can fail if a receiver or acoustic release has been damaged or if the release is blocked or fouled.

More details regarding specific receivers or acoustic releases can be found in the corresponding user manual.



IMPORTANT SAFETY INFORMATION

What to Do?

1. **Employ safety procedures** required by the country or state in which you are working.
2. **Always use** protective clothing, gloves and glasses, and work in a well-ventilated area.
3. Treat any receiver or acoustic release pulled from the water as if it has the *potential* to be pressurized or contain a breached battery. Point it away from yourself and others.
4. If a receiver or acoustic release shows any **signs of internal pressure or breach**, do NOT attempt to open it. Handle it very gently and store it in an isolated location, then call VEMCO Customer Support (see section 9.3 for contact information).

Such signs may include:

- Popped or bulging pressure release
- Air or water seeping from seams
- Signs of internal water (e.g. sloshing sound)
- Excess weight
- Signs of physical damage

If a receiver or acoustic release shows **signs of damage or heavy biofouling**, handle with extreme caution, and use all necessary protective equipment.



WARNING

If the VR2W is not used in the manner specified in this manual, then the manufacturer's warranty protection may be voided.

Summary of Manual

This manual is intended to provide VEMCO users with the information they require to use the VR2W receivers. VEMCO highly recommends that the user fully read the manual before using the equipment or the VUE software.

Section 1: Introduction

Getting to know the VR2W receivers

Section 2: Getting started

Getting the VR2W ready, including powering the VR2W, opening and closing the case, and initial tests

Section 3: Communication

Talking to the VUE software, and how to use VUE with a VR2W

Section 4: Deployment

Important points to consider in a deployment plan and the most common attachment method

Section 5: Maintenance

How to care for the equipment and prepare it for storage, including removing the battery

Section 6: Additional Information

Additional information about the VR2W that is good to know but not mandatory for basic operations

Section 7: Common Questions

Answers to frequently asked questions related to using the VR2W receivers

Section 8: Troubleshooting

Solutions to common issues that may arise

Section 9: Appendix

**For the latest versions of user
manuals and software, visit
www.vemco.com.**

Table of Contents

1	Introduction.....	1
1.1	System Overview	1
1.2	VR2W Case	2
1.3	Case parts	3
2	Getting Started	4
2.1	Open the VR2W Case.....	4
2.2	Install Battery	7
2.3	Close the VR2W Case	9
2.4	Testing.....	11
2.4.1	In-Air Test.....	11
2.4.2	In-Water Test.....	11
3	Communication.....	12
3.1	Install VUE software.....	12
3.2	Connecting with Bluetooth	13
3.2.1	Using INTERNAL Bluetooth.....	13
3.2.2	Using the EXTERNAL Bluetooth Adapter	13
3.3	Activate Wireless feature	14
3.4	Establish communication	15
3.5	Record mode	17
3.5.1	Start a Study.....	17
3.6	Offload Data.....	19
3.6.1	Disconnect communication with receiver	20
4	Deployment	21
4.1	Deployment Facts/Tips	21
4.1.1	Mooring	21
4.1.2	Spacing	21
4.1.3	Biofouling.....	21
4.2	Mooring Line Attachment	22
5	Maintenance	24
5.1	Battery Replacement	24
5.1.1	Disconnecting and Removing Battery	24
5.2	O-ring Care	25
5.2.1	Remove O-rings	25
5.2.2	Clean O-ring Surfaces	26
5.2.3	Install O-ring	28
5.3	Storage	28
6	Additional Information.....	29

6.1	Flash Memory	29
6.1.1	Time required to fill memory	29
6.1.2	Time required to offload memory	30
6.2	Status Light Flashes	30
6.3	Set Local options	31
6.4	Battery	32
6.4.1	Battery Life	33
6.5	Case External Dimensions	34
6.6	Update Firmware	35
6.7	Map Updating	37

7 Common Questions39

7.1	VUE related questions	39
7.1.1	How/when do I change my receiver code map?	39
7.1.2	What is initialization?	39
7.1.3	Why does VUE create two .vrl file types?	39
7.1.4	What Date/Time format is my data stored in the receiver and displayed in VUE?	40
7.1.5	What does the “Hide this (window) in future” mean?	40
7.1.6	How do I open the <i>Options</i> window?	41
7.2	VR2W related questions	42
7.2.1	How much detection range can I expect from my tags and receivers?	42
7.2.2	How long will my VR2W battery last?	42
7.2.3	Does receiver orientation matter?	42
7.2.4	At low tide my VR2W receiver will be exposed to direct sunlight, does this matter? ..	42

8 Troubleshooting.....43

8.1	VUE related troubleshooting	43
8.1.1	Bluetooth Troubleshooting	43
8.1.2	I cannot connect to my VR2W receiver	43
8.1.3	These detected ID’s don’t belong to me	43
8.2	VR2W case related troubleshooting	44
8.2.1	The threads have been damaged	44
8.2.2	I think the case might be pressurized	44

9 Appendix45

9.1	VR2W Metal/PVC Casing	45
9.2	Cleaning Instructions	47
9.3	Contact Information	47
9.4	VR2W Specifications	48
9.5	Warranty and Disclaimer	50
9.6	Glossary	51
9.7	Index	52

Regulatory Compliance Information

The VR2W-xxxx-110/111 complies with Part 15 of the FCC Rules. Operation is subject to the following two conditions: (1) this device may not cause harmful interference and (2) this device must accept any interference received, including interference that may cause undesired operation

The VR2W-xxxx-110/111 has been tested and found to comply with the limits for a Class B digital device, pursuant to Part 15 of the FCC Rules. These limits are designed to provide reasonable protection against harmful interference in a residential installation. This equipment generates, uses, and can radiate radio frequency energy and, if not installed and used in accordance with the instruction manual, may cause harmful interference to radio communications. However, there is no guarantee that interference will not occur in a particular installation. If this equipment does cause harmful interference to radio or television reception, which can be determined by turning the equipment off and on, the user is encouraged to try to correct the interference by one or more of the following measures:

- Reorient or relocate the receiving antenna
- Increase the separation between the equipment and receiver
- Connect the equipment into an outlet on a circuit different from that to which the receiver is connected
- Consult the dealer or an experienced radio/TV technician for help

WARNING: Changes or modification not expressly approved by AMIRIX Systems Inc. could void the user's authority to operate the equipment.



WARNING

If the VR2W is not used in the manner specified in this manual, then the manufacturer's warranty protection may be voided.

© (2018) AMIRIX Systems Inc. All rights reserved. The information contained herein includes information which is confidential and proprietary to AMIRIX Systems Inc. and may not be used or disclosed without prior written consent of AMIRIX Systems Inc.

The *Bluetooth*® word mark and logos are owned by the Bluetooth SIG, Inc. and any use of such marks by AMIRIX Systems Inc. is under license. Other trademarks and trade names are those of their respective owners.

1 Introduction

1.1 System Overview

The VR2W is a submersible, single-channel acoustic receiver capable of identifying VEMCO coded transmitters. The receiver operates on a factory set frequency of either 69 kHz or 180 kHz. VR2W receivers can decode uniquely coded pingers and sensor transmitters that operate on the same frequency as the VR2W.

The VR2W is housed in a corrosion resistant cylindrical plastic high pressure case, and incorporates an integral hydrophone at the tapered end of the case. The VR2W features include *Bluetooth*® wireless technology, a Smart LED, 16 megabytes of data storage, record mode, and a replaceable battery (single Lithium cell).

The VR2W records the tag code number, the date/time of valid detections, and sensor data if the tag received is equipped with a sensor. This information is stored in the VR2W memory until it is downloaded from the receiver using *Bluetooth* wireless communication and a PC running VUE software.

Some common uses for VR2W receivers are:

- Monitoring fish movements using acoustic gates across shorelines
- VEMCO Positioning System (VPS) arrays to track animals within a specific area



VR2W Quick Facts

Dimensions	308 mm (12.125") x 73 mm (2.875") diameter
Weight	1190 g in air; 50 g in water
Receive Frequency	VR2W-69kHz: 69.0 kHz VR2W-180kHz: 180.0 kHz
Battery Life	VR2W-69kHz: typically 15 months VR2W-180kHz: typically 8 months
Memory	8 MB (~0.8 million detections) or 16 MB (~1.6 million detections)
Operating temperature	-5°C to +40 °C; Water <i>must not freeze</i> .
Maximum Depth	500 meters (730 psi)
Software	VEMCO User Environment (VUE) software



WARNING

The VR2W pressure case and seal have a maximum static depth rating of **500 meters** (730 psi). Physical shocks to the receiver, such as bumping into a solid object, when it is at any depth can result in a considerably higher pressure on the casing than just the depth pressure and water may enter the VR2W case. If the O-rings or their mating surfaces are dirty or damaged, then water may also enter the receiver case. If you are suspicious that water has entered the receiver, then follow the suggestions in section 8.2.2 for troubleshooting a pressurized case.

1.2 VR2W Case

The VR2W receiver is housed in the black plastic high pressure case. The case consists of an outer cylinder that is removed to install the D-cell Lithium battery, and the endcap which houses the hydrophone and connects to the plastic internal casing. When the outer cylinder is removed, the internal casing protecting the electronics can be seen. There are two types of internal casing, the older metal/PVC casing and the current plastic casing. This manual focuses on the current case type; instructions for the older case are found in the appendix (section 9.1).

A crucial part of the VR2W is the hydrophone, located at the top of the receiver. The hydrophone is similar to a microphone – it “listens” for sounds and transfers them to the electronics inside the receiver. Be very careful not to bump the hydrophone or damage may occur that may prevent the receiver from detecting tags.

The VR2W is only capable of listening to one frequency so that frequency must be selected at the time of ordering. The frequency chosen is based on the coded tags that will be used and can be either 69 kHz or 180 kHz. The frequency is reflected in the name of the receiver, the VR2W-69kHz or the VR2W-180kHz.

Externally there are physical differences between the VR2W-69kHz and the VR2W-180kHz which make it easier to identify the operating frequency at a glance. The VR2W-180kHz has a smaller hydrophone than the VR2W-69kHz, and the identification band around the middle of the VR2W-180kHz receiver has green text while the VR2W-69kHz has blue text. The dimensions of the two cases are slightly different – diagrams are found in section 6.5.

The cases operate in the same manor so they’ll be described simply as a VR2W in this manual.

Visible External Differences:

1. Hydrophones are different sizes
2. Serial Number label is a different colour.
Blue = 69 kHz
Green = 180 kHz



VR2W-69kHz

VR2W-180kHz

1.3 Case parts

The VR2W is shipped closed, as shown below. The battery may be installed in the case but not connected. The case only needs to be opened when the battery must be connected or replaced. Connecting the battery is explained in Section 2, along with opening and closing the receiver case. Replacing the battery is explained in Section 5.1.



Hydrophone: the receiver's "microphone" and most delicate part.



Do not bump the hydrophone or the receiver may be damaged and unable to detect transmitters.

Comm Key Hole: Place the narrow end of the Comm Key in here to prepare for communication. Section 2 has more information on the Comm Key.

Status Light (LED)/Release Valve: The light flashes red to indicate the receiver's status. Section 6.2 has the full description.

The Release Valve will open *if* the internal pressure is greater than the external pressure (see section 8.2.2). **Never cover this valve.**

Cable Tie Groove: These grooves (there are two) are used to attach the VR2W to a line – see section 4.2.

Identification Label: Contains product name and number, contact information, serial number, and important warnings.

At a glance, the blue text indicates receiver is a VR2W-69kHz and green text a VR2W-180kHz.

Cable Tie Groove: This is the second of the two grooves.

Attachment Hole: This hole, which is almost 10 mm in diameter, is used with the Cable Tie Grooves to secure the VR2W while it is deployed. Section 4.2 has more attachment details.

Status Light (LED) Meanings:

- No flashes = no power
- 2 quick flashes every 5 sec = Recording Mode
- 2 quick flashes every 10 sec = Memory Full
- 1 quick flash = acoustic ping received
- 1 bright, long flash = detection written to memory
- 1 long flash per sec = Ready for *Bluetooth* communication
- On (solid) = communicating with VUE

2 Getting Started

Before the VR2W can begin recording detections, it must be powered. VR2W receivers are either shipped with the D-cell Lithium battery inside the case but not connected to the receiver, or with no battery inside the case. In either case, the VR2W case must be opened to power the receiver.

2.1 Open the VR2W Case

Two steel rods are necessary to properly open and close the VR2W case. Every shipment of new VR2W receivers includes a pair of steel rods.

The procedure for opening a VR2W case is the same regardless of the operating frequency of the receiver.

Want to watch this? Go to www.vemco.com/products/vr2w-69khz/?tutorials-and-tools to see the video.

STEP 1



Make sure there is **absolutely no water** on or near the VR2W case. Water, even in a small quantity, can damage the VR2W internal circuits beyond repair. If the VR2W is attached to a wet rope, remove the receiver from the rope before opening the case.



This also means the electronics cannot be exposed to a **sudden change in temperature and humidity** that will cause condensation to develop on the electronics and destroy the receiver.



WARNING

It is vitaly important that the electronics inside the receiver case **do not come in contact with any water** or the receiver will be damaged. For this reason, VEMCO recommends the VR2W be opened in a controlled environment and not in the field or on the deck of a boat.

STEP 2

Place the VR2W on a clean, flat surface so the hydrophone (tapered end) is hanging over the edge enough that the large hole is past the edge of the surface. **DO NOT** let the receiver fall off the surface.

TIP: A non-slip surface, such as a rubber mat, helps keep the VR2W in place while opening it.



Continued...

STEP 3

Insert one steel rod into the hole that runs through the diameter of the case near the flat end of the VR2W. Position it so most of the rod is on the left side of the receiver as shown.

Place a hand on the back of the receiver to hold it in place. The back of the receiver often “jumps” during Step 4 so be prepared.

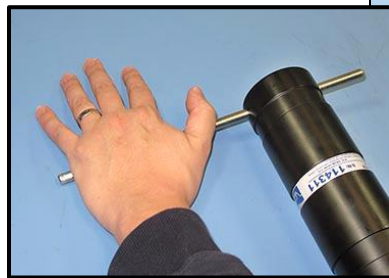

STEP 4

Insert the other steel rod into the hole in the Comm Key Hole on the end-cap of the receiver and hold on to the rod – it will slide right through the hole and potentially damage something below. Make sure the rod is fully inserted into the hole or damage may occur to the Comm Key Hole.

Apply pressure to the rod in the COMM Key hole to turn it in a counter-clockwise direction when you are facing the hydrophone. The rod at the back of the receiver acts as a brace while you apply pressure, but be careful of it “jumping” off the flat surface.

Continue to rotate the rod, and therefore the end-cap, until turning become easier.



STEP 5

Remove the steel rods from the VR2W case and set them aside. Be careful not to let the one in the Comm Key slide through the hole and cause damage below.

Continue by hand twisting the end-cap in a counter-clockwise direction until the end-cap and outer cylinder separate.



Continued...



WARNING

DO NOT impact the threads on the end-cap or they will dent and prevent the VR2W case from closing. See section 8.2.1 for tips on thread care.

STEP 6

Slide the end-cap and cylinder apart until the battery compartment has cleared the cylinder. Be very careful not to damage the threads on the end-cap or the VR2W won't close and seal properly.



If the VR2W has a metal and PVC internal casing instead of the plastic internal casing shown, instructions are found in section 9.1.



WARNING

The internal casing surrounding the electronics is not waterproof. Water, even condensation from a humid environment, will enter the case and damage the electronics.

2.2 Install Battery

With the case open, you can install the new battery. If there is a used battery in the receiver, use the instructions found in Section 5.1.1 to remove the battery before inserting the new one.

Some VR2W receivers are shipped with the battery inside the receiver but not connected. If this is the case for your receiver, then move to Step 7 in the instructions below to power your VR2W.

Want to watch this? Go to <http://vemco.com/products/vr2w-69khz/?tutorials-and-tools> to see the video.

STEP 1

Verify that the O-ring inside the battery cavity is still at the back of the cavity.



STEP 2

Slide the Lithium D-cell battery into the battery section at the end of the receiver so the battery's wires are outside the case.



STEP 3

Insert the battery pin into one of the holes in the edge around the battery cavity and slide the pin across the end of the battery until the ends of the pin are both in the receiver case.

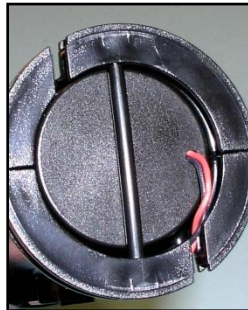

Downward force (see red arrow) may be required on battery end to get the pin started.

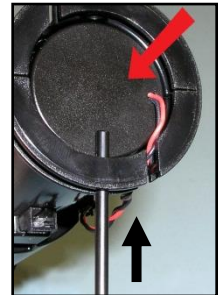

STEP 4

Check that both ends of the pin are flush with the case.



STEP 5

Place the battery wires into the gap in the end of the receiver case closest to the battery connector on the case. There are two gaps in the end of the case.

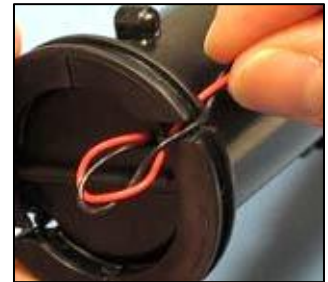

Continued...

STEP 6

Place the O-ring in the O-ring groove around the end of the case so the battery wires are inside the O-ring. This also holds the battery pin in place.



STEP 7

Position the receiver so you can see the LED light.

Connect the two battery connector halves together until a “click” is heard and the VR2W receiver’s light begins flashing.

NOTE: If the VR2W was in Recording mode (i.e. as Study had been initialized) when the battery was disconnected, then it will immediately return to recording detections after the battery has been replaced. Settings are not lost when the power is disconnected.



STEP 8

Gather any excess battery wire into the area at the end of the battery cavity (circled in yellow) and not along the side of the receiver casing. This reduces the chance of damage to the battery wires.

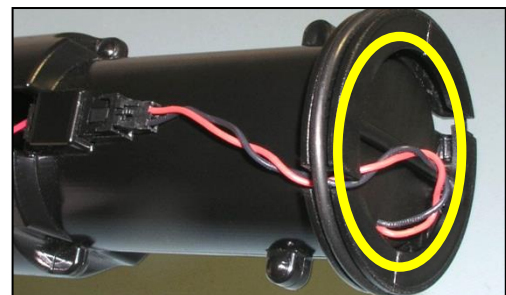

2.3 Close the VR2W Case

Before deploying or storing a VR2W receiver, the case must be properly closed and sealed to prevent damage to the electronics. Even humidity in the air can, over time, cause damage to the electronics so it's very important to keep the case sealed, with a functioning desiccant pack inside, as much as possible. Important information about storing a VR2W is found in section 5.3.

Want to watch this? Go to www.vemco.com/products/vr2w-69khz/?tutorials-and-tools to see the video.

STEP 1

Make sure the serial number around the outer cylinder matches the serial number on the internal casing. This is particularly important when more than one VR2W receiver is open at the same time.



STEP 2

If this is the first time closing the VR2W case, then make a visual inspection of the O-rings and the O-ring surface inside the outer cylinder to be sure they are clean, properly greased, undamaged, and debris free. Details are found in section 5.2.

If the VR2W has been deployed previously, then follow the O-ring inspection/replacement instructions in section 5.2 to improve the seal in the case.



STEP 3

Place a new desiccant pack (if the existing one has been deployed) in the bottom of the Outer Cylinder so both ends of the pack are touching opposite sides of the cylinder's wall.

A desiccant pack has been included in the bottom of the VR2W to reduce the occurrence of condensation in the VR2W. One of these packs should remain in the receiver case during storage and deployment.

We recommend that you replace the desiccant pack with each deployment and with each battery replacement cycle.

More information on the availability and usage of these packs is located on our website, www.vemco.com.



Continued...

STEP 4

Slide the plastic internal casing into the Outer Cylinder, battery end first, until the first threads are inside the outer cylinder. Ensure that the O-rings remain properly seated in their grooves as the end-cap is moved into the outer cylinder.



STEP 5

Turn the end-cap in a clockwise direction (when looking at the hydrophone) until it becomes too hard to turn by hand.



STEP 6

Place the VR2W on a clean, flat surface so the hydrophone (tapered end) is hanging over the edge enough that the large hole is past the edge of the surface. **DO NOT** let the receiver fall off the surface. **TIP:** A non-slip surface, such as a rubber mat, helps keep the VR2W in place while closing it.

Insert one steel rod into the hole that runs through the diameter of the case near the flat end of the VR2W. Position the rod so the majority of the rod is on the right side of the case. This helps brace the receiver while the case is being closed.



STEP 7

Insert the other steel rod into the Comm Key Hole on the end-cap and hold on to the rod – it will slide through the case and potentially damage something below. Make sure the rod is fully inserted or damage may occur to the Comm Key Hole.

Place a hand on the back of the receiver to hold it in place.

Apply pressure to the rod in the endcap so it turns in a clockwise direction when you are facing the hydrophone.

Continue moving the rod until the end cap touches the edge of the outer cylinder. Don't over-tighten the case pieces together or they may be damaged.

Remove the steel rods from the VR2W case.



2.4 Testing

Before deploying a VR2W, it is wise to test it with a tag to verify that it is operating properly. This test also creates a VRL file containing all the configuration information for this receiver – handy to keep as a record of the receiver’s configuration.

Perform air tests away from electrical noise sources such as motors, PC screens, or fluorescent lights.

Tests can, and should, be done in both air and water.

2.4.1 In-Air Test

The VR2W can detect coded pingers in air, but at a much reduced range compared to their range capabilities in water. Perform air tests away from electrical noise sources such as motors, PC screens, or fluorescent lights.

To perform an in-air test, follow the steps below.

1. [Activate](#) the *Bluetooth* feature on the VR2W (section 3.3).
2. Establish [communication](#) between the VR2W and VUE software (section 3.4).
3. [Begin a Study](#). Section 3.5.1 has the details of how to begin a study, also known as initializing a receiver.
4. Disconnect the wireless communication with the VR2W (click the red box with the “X” in the [receiver ribbon](#)).
5. Activate a tag that operates on the same frequency that the VR2W operates and place it near the hydrophone. For 69 kHz equipment, place the tag less than 30 cm (12”) away from the VR2W-69kHz hydrophone; for 180 kHz, place the tags less than 8 cm (3”) from the VR2W-180kHz hydrophone. Position the tag so the side of the tag is facing the side of the VR2W hydrophone.
6. Wait while the VR2W records the tag(s) near it. You can watch the flash patterns as the tag is detected and the data is stored in memory. Each faint flash of the Status Light (LED) is a received ping and a long, bring flash is a stored detection. If the flash patterns are different, compare it to the [Status Light Meanings](#) chart (section 6.2).
7. [Communicate](#), using VUE, with the VR2W again. Before continuing, take a quick look at the number of detections and pings received listed in the receiver status information.
8. [Offload](#) the data that was collected during the test (section 3.6), creating a VRL file.
9. View the data to verify that the data was stored and retrieved without problems. Instructions for viewing data are found in the VUE manual.

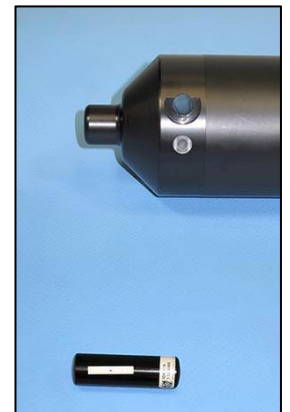

2.4.2 In-Water Test

Tests performed in water are almost identical to the in-air test explained above. The only difference is that the tags should be positioned farther from the receivers – 5 meters is suggested. In-water tests are often performed to establish an ideal range for the VR2W receivers in the environment in which they are moored. Details of conducting a Range Test are found at www.vemco.com/customer-service/?cs-tutorials.

3 Communication

The VR2W uses *Bluetooth* communication between the receiver and the VUE software. This feature dramatically increases data offload speed compared to the cabled communication of the retired VR2 receiver. For example, to offload 2 MB of data requires 3.3 minutes for the VR2W to accomplish but it would have taken the VR2 more than 75 minutes. A comparison table is located in section 6.1.2 for more information.

Bluetooth is still a relatively new standard and we have observed that not all *Bluetooth* devices are created equally or work reliably. To ensure successful operation with the VEMCO VR2W, we provide our users with a *Bluetooth* USB adapter in the VR2W Communications Package that we are confident will provide reliable functionality.

NOTE:

Due to *Bluetooth* characteristics in water, the VR2W must communicate with the *Bluetooth* USB adapter **through air** (typical range is 10 meters).

3.1 Install VUE software

VUE software is used to communicate with the VR2W receiver, allowing studies to be setup and data to be offloaded. The software requires either Windows VISTA, Windows 7, 8, or 10.

NOTE: A *Bluetooth* USB adapter is required for operation with the VR2W receivers because they use *Bluetooth* communication. See section 3.2 for details.

STEP 1

Follow the link in the VUE email you received. VUE is also available at www.vemco.com/downloads.



STEP 2

Click "Next" when the Install Shield Wizard begins.

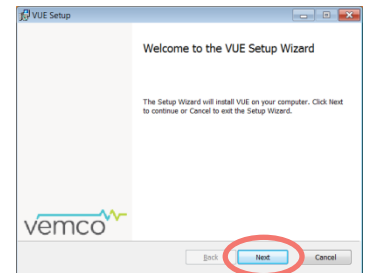

STEP 3

Read the license agreement and select "I accept" and "Next" if you agree to the terms.



STEP 4

Click "Next" to install VUE in the folder shown, or click "Change" to select a different folder.

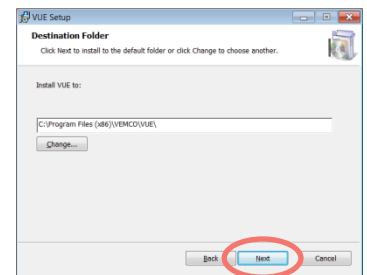

STEP 5

Click the “Install” button and wait while the VUE software is installed.

Click “Next” when it becomes enabled.

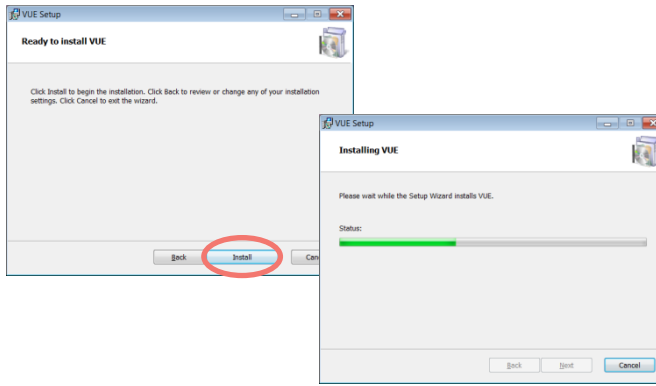

STEP 6

Click “Finished” to exit the setup wizard.

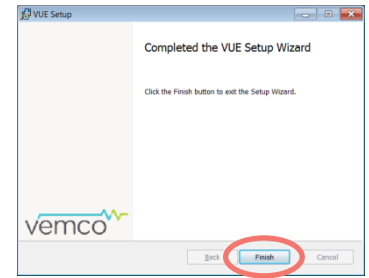

3.2 Connecting with Bluetooth

There are two ways to connect your PC or laptop through Bluetooth for communication with your receiver. Use the method that suits the equipment you have.

3.2.1 Using INTERNAL Bluetooth

There are a number of Windows Operating Systems (OS) PCs, laptops, and tablets equipped with **internal Bluetooth** capable of communicating with VEMCO receivers through the VUE software.

IMPORTANT: If you want to use the internal Bluetooth, **DO NOT INSERT** the VEMCO supplied Bluetooth adapter into your device, and follow the steps below.

1. Open VUE software (latest version available from <http://vemco.com/downloads>).
2. Observe the Bluetooth icon at the bottom of the window. In most cases, it will look like the Bluetooth icon shown at right, indicating that you’re ready to communicate with VEMCO Bluetooth equipment, like a VR2W or VR2AR. If VUE is not able to perform Bluetooth communication, you will see a **red “X”** through the icon.



NOTE: Communication difficulties may occasionally occur when the red “X” is not present. If this happens, follow the suggestions in the [Bluetooth Troubleshooting Guide](#) available on our website.

3. Connect to the receiver. Instructions are found in the receiver’s user manual. If a Bluetooth connection cannot be established with the receiver, try using the VEMCO-supplied Bluetooth USB adapter as described in the next section.

3.2.2 Using the EXTERNAL Bluetooth Adapter

If your computer does NOT have internal Bluetooth capability, use the VEMCO-supplied USB Bluetooth adapter, as described here.



Attach the Bluetooth adapter (may not be as shown) to any USB port on your computer.

If you are using Vista, then you must install VUE 2.1.3 or greater for the proper adapter drivers. Windows 7 and greater have the necessary drivers installed.

3.3 Activate Wireless feature

The *Bluetooth* feature in a VR2W receiver must be activated before the VUE software will be able to find and connect to the VR2W. Activation requires a specially designed Communications Key (also referred to as “Comm Key”).

The Communications Key is a stepped cylinder made of black plastic material. A strong magnet is contained in the smaller end of the Comm Key and should be kept away from any magnetically sensitive materials. An orange float is attached to the Comm Key case for easier handling and locating of the key. This key functions with other VEMCO receivers that use a Comm Key, such as the VR4-UWM.



WARNING



The Communication Key contains a **strong magnet**. Do not put it near magnet-sensitive materials, such as CRT computer monitors or magnetic stripes, as they could be seriously damaged.

STEP 1

Slide the smaller end of the Comm Key in the Comm Key Hole in the VR2W, near the hydrophone.



STEP 2

Wait until the VR2W’s LED begins flashing a bright, long, steady flash once a second. The wait time is less than five seconds.

Remove the Comm key.

Bright flash every second



The flash pattern in a VR2W indicates the mode (state) the receiver is in at the time. A bright, long flash once a second indicates that the VR2W is now ready for wireless communication but is not yet in communication with VUE.

The Comm Key can be removed from the VR2W once the light is flashing.

TIP

It’s helpful to place the VR2W **within 10 meters** (32 feet) of the operating *Bluetooth*® USB adapter **before** activating the VR2W.

3.4 Establish communication



After the VR2W has been activated (section 3.3), it is ready for wireless communication with the VUE software. The VR2W must be within communication range of the *Bluetooth* USB adapter, which is typically 10 meters (32 feet) but can vary based on physical and wireless obstructions/interference. Due to Bluetooth® wireless technology characteristics in water, the VR2W must communicate to the *Bluetooth*® USB adapter through air.

VR2W communication range:
10 meters (32 feet) through air
from *Bluetooth*® USB adapter.

STEP 1

Open the VUE software. The software will scan for any active devices within communication range.

Wait while the software searches for receivers.

TIP: If VUE can't find your receiver(s), try again. It's not uncommon for a Bluetooth scan to miss devices, especially if other wireless devices are in the area.

When the software finds the receiver, a VR2W icon will be displayed in the "Bluetooth Devices" section of the Home tab with the receiver's serial number for identification. It will display all *Bluetooth*® activated receivers (LED is flashing bright, long, steady flashes) within communication range, which is approximately 10 meters.

If wireless communication has not been activated on the VR2W, then activate communication (section 3.3) and click "Device Scan" on the VUE software's Home tab.

Wait while the software searches for receivers.

All *Bluetooth*® activated VEMCO receivers within communication range will be displayed when a Device Scan is performed.

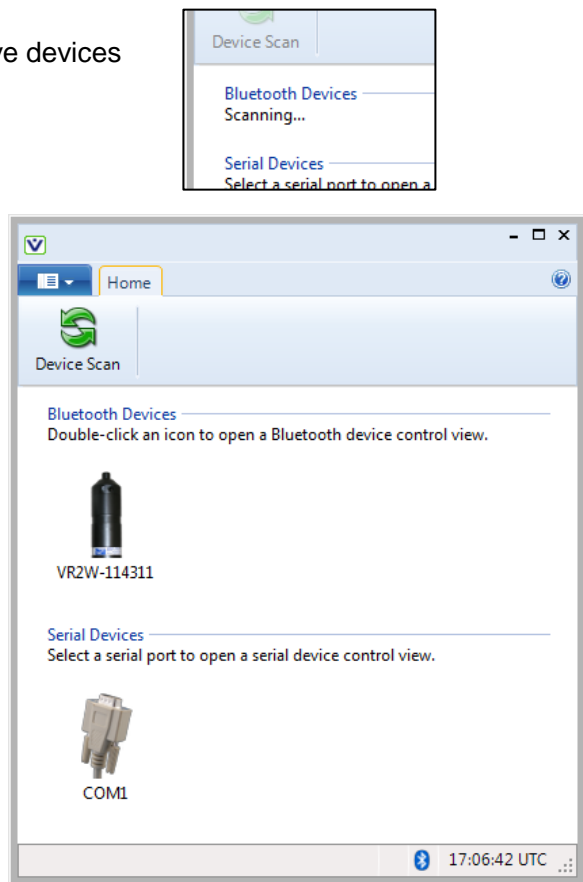

STEP 2

Double-click on the receiver icon of the desired VR2W (serial number is listed under the icon) and wait while communication is established. You'll know communication was successfully established when information pertaining to this receiver is displayed and the receiver's LED is on continuously. The "Link Status" in the VUE window also changes to "Connected".

TIP: VUE can communicate with up to seven wireless receivers simultaneously.



The Receiver Tab

Each receiver currently in communication with VUE has a tab at the top of the VUE window. This tab identifies the type and serial number of the receiver. Click on a tab to bring it to the front of all the tabs, making the receiver's information visible.

Receiver type and serial number

The ribbon section contains tasks and advanced options, including offloading data, firmware upgrades, recording (initializing) and ending communication.

Receiver information specific to this VR2W is contained in the center of the window.

VR2W 69kHz
Ross River Study

Serial Number: 114311
Clock: 2013-02-14 17:07:55
Receiver Status: Recording

Firmware Version: 3.0.4
Battery: 3.53 V
Study Start: 2013-02-12 17:39:36

Bootloader Version: 3.0.1
Detection Log Size: 15.9 kB (0.2%)
Station: None

Hardware Version: 5
New Data: 15.9 kB
69 kHz map: MAP-113

Memory Size: 8.19 MB
69 kHz: 1429 detections, 16190 pings

Link: Bluetooth
Link Status: Connected

Detection Monitor

VR2W detections will be displayed here as they arrive...

2013-02-13 17:57:24	A69-9001-1025
2013-02-13 17:57:39	A69-9001-1025
2013-02-13 17:57:54	A69-9001-1025
2013-02-13 17:58:09	A69-9001-1025
2013-02-13 17:58:24	A69-9001-1025

Disable Timeout
 Save to File
Clear

The **Detection Monitor** section displays detections that are received by the VR2W while it is connected to VUE. These detections are saved in the VR2W memory. They can immediately be saved to the PC once "Save to File" is selected (see box at right).

A checkmark at "**Save to file**" will begin a file to save all detections received from that point forward. The file name appears in the Detection Monitor and the file is saved to the selected directory (see VUE user manual).

The received detections visible in the Detection Monitor are not automatically saved.

Selecting "**Disable Timeout**" will keep the VR2W "awake" (*Bluetooth* communication is active) until the VUE software is closed. This is helpful when doing in-air testing. Leaving the Timeout in place (no checkmark) allows the *Bluetooth* communication to eventually timeout and close.



CAUTION: Verify the receiver you are communicating with is **the intended unit**, particularly before initializing and erasing receiver memory files, or data could be lost. Communication can occur with any VR2W with *Bluetooth*® wireless technology activated within a 10 meter range (typical range in air).

3.5 Record mode

The default operating mode of the VR2W is to record received pings and detections, even while connected to VUE software. The VR2W enters Record Mode when any of the following events occur:

- The battery is installed
- A study is started in the VUE software
- Bluetooth communication is closed while recording is paused

Bluetooth communication can close when any of the following events occur:

- The VR2W has received no communication from VUE for 10 minutes
- The Receiver Tab in VUE software is closed by the user
- VUE closes communication automatically after 30 minutes of inactivity from the user (unless the VUE option is disabled)

These events were chosen so that a VR2W receiver would always be deployed in Record Mode. The only way a VR2W wouldn't be in Record Mode is if the memory was full or the battery was removed (see section 5.1).

3.5.1 Start a Study

Setting up a study allows you to enter information in the VR2W that will aid you in identifying its deployment location and even a description of the study, such as the study's title or other information. This information is stored in the VR2W and offloaded with the data. It can be very useful when data is being organized in the VUE software.

Always backup previously offloaded data **before** initializing a new study. Internal memory is erased.

STEP 1

Click the red and blue "Start Recording" button found in the receiver tab's ribbon. This button is not available if communication between receiver and VUE software is not present.

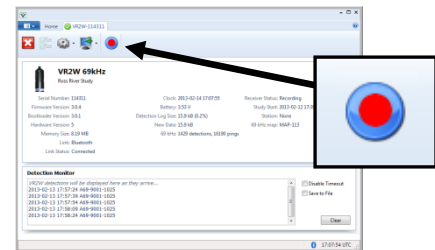

STEP 2

Review the PC clock time listed in the dialogue box that opens. The receiver will be set to UTC time based on the current time of the PC so the PC time and the UTC offset must be correct. If the time or UTC offset are not correct, then click "Cancel" and make the necessary corrections before returning to start the study. If the time and UTC offset are correct, then click the "OK" button to continue.



CAUTION: It is vital that the PC clock be correctly set to your local time, including time zone, **before the VR2W is initialized.**

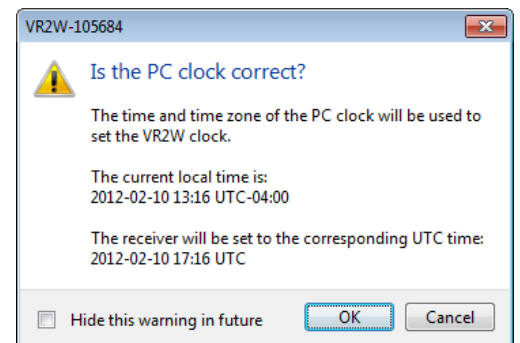

Continued...

STEP 3

Select one of the three options displayed.

- **ERASE:** when the data stored in the VR2W has already been offloaded and you wish to erase the data and begin a new study.
- **OFFLOAD:** when the data has not been offloaded from the VR2W or if there is any uncertainty about the data being offloaded.
- **CANCEL:** when you wish to continue the study that is currently running in the VR2W receiver. No changes to the study will be made.

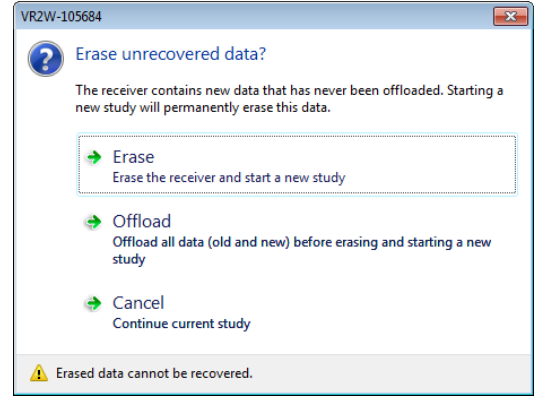

CAUTION: Verify the receiver you are communicating with is **the intended unit**, particularly before initializing and erasing receiver memory files, or data could be lost. Communication can occur with any VR2W with *Bluetooth®* wireless technology activated within a 10 meter range (typical range in air).



WARNING

Initializing the VR2W will erase the receiver's memory. **Retrieve all detection logs before the VR2W is initialized.**

STEP 4

Enter a description of the study in the Study Configuration window. The station name is optional and can be selected from a list of existing stations (if a database is open) or by simply typing in the "Station Name" line to create a new station. If this station is a fixed position, then click a check mark in the "Fixed Station Position" box and enter the latitude and Longitude. If the fixed location information is already entered for an existing station, then the lat/long data will appear as soon as the station name is selected from the drop-down list.

- Enter a description/title for this study.
- Select Fix Station to enter lat/long location of VR2W.
- Advanced Settings includes changing the map and blanking interval.

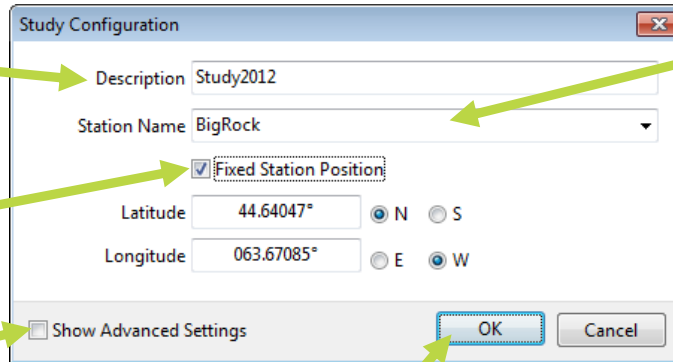

- Select or enter a station name.
- Create a new station by entering the name in the Station Name line.
- Choose unique station names for each deployment location.

Click OK to put the VR2W in Recorder Mode and begin the study.



WARNING

Incorrectly changing the Advanced Settings can prevent the VR2W from hearing your tags. Only do so under VEMCO's direction.

How do I know the VR2W is recording?

Watch the red Status Light (LED). Two quick, bright flashes every 5 seconds indicate the VR2W is in Record Mode.

3.6 Offload Data

After data has been collected by a VR2W, either during testing while in air or while in the water, that data must be offloaded to be accessed and viewed. Data can only be offloaded from a VR2W receiver while it is in communication with the VUE software through *Bluetooth®*. Follow the steps below to offload data.

STEP 1

Activate the wireless feature on the VR2W receiver (section 3.3)



STEP 2

Establish communication between the VR2W and the VUE software (section 3.4).



STEP 3

Click the “Offload data” icon in VUE’s receiver ribbon and choose to either offload all the data stored in the VR2W, which will duplicate the data already offloaded, or offload just the data that was stored since the last offload was performed.

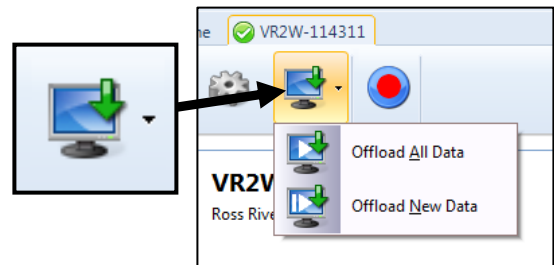

STEP 4

Verify that the PC clock is correct. If it is, then click “OK” to continue. If not, then correct the PC clock time and return to VUE to offload the data.

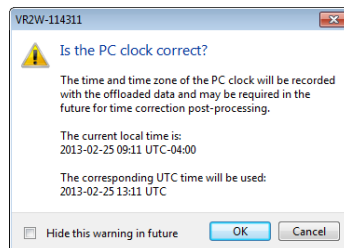

STEP 5

Wait while the data is offloaded. Progress is shown at the bottom of the VUE window. The name of the file created is displayed when the data has successfully been offloaded.

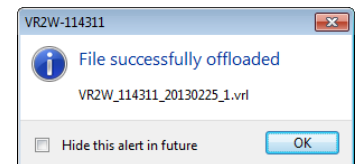

If a database is open in VUE when data is about to be offloaded, an additional dialog box appears asking if the offloaded data should be imported directly into the open database. If “NO” is selected, then the file(s) will be saved to the directory and in the format selected in the Offload tab of the *Options* window (see VUE manual for details) and will not be imported to the database. The created file choices are:

- VRL files only
- VRL files and CSV file
- VRL files and legacy VR2 files

The offloaded data will be stored in the selected file type(s) and location regardless of if the data is directly imported in to the VUE database or not.

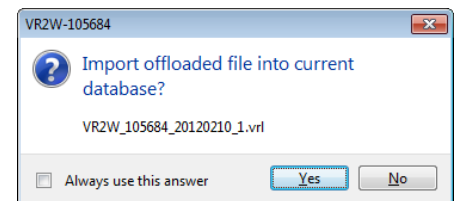

If a database is not open when data are offloaded, then the data will automatically be saved in the file format(s) and directory selected in the *Options* window.

3.6.1 Disconnect communication with receiver

Click the “Close View” button (red box with white X) to disconnect the communication between the VR2W and the VUE software. A window will appear to confirm that you want to close the VR2 View window.



When the communication is disconnected, the VR2W resumes recording with the last study that was initialized. Ending communication does not re-initialize the receiver.

4 Deployment

How a VR2W is deployed is driven by the environment it is being deployed in and the type of study being performed. Some important points to keep in mind when designing a deployment plan for your VR2W receivers are explained here. The common method for attaching a VR2W to a mooring line is also given, along with the dimensions of the VR2W cases.

4.1 Deployment Facts/Tips

4.1.1 Mooring

VR2W receivers are moored in many configurations often reflecting the bathymetry and oceanographic/weather conditions. A simple mooring design generally works well. However, in rougher conditions, heavier weights and mooring lines are usually required. If a bottom mooring is desired, the VR2W should be positioned above the floor such that it has an unobstructed “view” of tagged animals within their expected acoustic range. Ensure the VR2W’s hydrophone is unblocked (e.g. do not position an air filled buoy directly above the hydrophone) and free of any biofouling. In high flow locations, you may consider using hydro dynamically shaped buoys and low profile anchors.

For the best horizontal range, mount the VR2W receiver in a vertical position. If the VR2W is deployed close to the bottom of the water, mount the VR2W with the hydrophone pointing up to the surface. If the VR2W is deployed close to the surface of the water, then position the VR2W so the hydrophone is pointing down.



CAUTION: The hydrophone must be kept **free of mooring lines and obstructions**. Objects around the hydrophone will adversely affect the detection range of the VR2W receiver.

4.1.2 Spacing

Receiver spacing is generally determined based on range testing and historical acoustic data. Our position is that you should try to space receivers such that you achieve good detection probability in most or all weather conditions. It is not always necessary to have 100% coverage if you have several other locations where you know the animals will be passing through. However, if you wish to accurately quantify the passing of animals through receiver locations then you should strive for 100% detection probability. Typical spacing is usually between 100 and 1,000 meters.

See the Gate Design tutorial at www.vemco.com

4.1.3 Biofouling

Some customers use a rubber shrink tape, such as DAFLEX ST250 Cold Shrink Tape, available from Digikey (W211-ND), to prevent biofouling on the VR2W receiver. It can be used to cover the entire receiver case or just the Comm Key Hole and does not leave a glue residue when it’s removed. Another option is to use an antifouling paint, such as Interlux Micron CSC. **When using antifouling paint, consult the manufacturer’s safety data sheet and follow their recommended handling procedure (safety glasses, gloves, etc.)**



Never cover the Status Light (LED)/Release Valve.
The release valve *must* be able to pop open if needed and must not be blocked by tape or paint.

4.2 Mooring Line Attachment

The common method used to attach a VR2W receiver to a mooring line is to use five cable ties (zip tie or tie-wrap) with the following characteristics:

Non-reusable lashing cable ties

- 388 mm (15.25") long
- 7.5 mm (0.3") wide
- UV protected
- 120 lb tensile strength

Suggested minimum:

3/8" diameter
nylon rope

A set of five cable ties is shipped with each new VR2W receiver and more may be purchased from VEMCO (product number HWE 507450).

Follow the instructions listed below to attach the VR2W receiver to the rope used as the mooring line. A minimum rope size of 3/8" diameter nylon rope is suggested.

STEP 1

Identify the location on the rope where the bottom of the VR2W receiver will be attached.



STEP 2

Twist the rope so the strands of the rope separate from each other and an opening in the rope is seen. This is referred to as opening the "warp in the rope".



STEP 3

Slide one of the cable ties through the center of the rope and the Attachment Hole.



STEP 4

Latch and tighten the cable tie so the head of the cable tie is next to the rope.



STEP 5

Open the warp in the rope again and slide another cable tie through rope so it lines up with the bottom half of the lower groove around the body of the VR2W.

Tighten the cable tie so the tie's head is next to the rope.



STEP 6

Wrap a third cable tie around the VR2W receiver and the rope so the cable tie occupies the top half of the lower groove in the VR2W body. The bottom half of the groove is already occupied by the cable tie from Step 5

Latch the cable tie so the head of the cable tie is over the rope.



STEP 7

Open the warp in the rope next to the groove closest to the hydrophone and slide another cable tie through rope so it lines up with the top half of that groove.

Tighten the cable tie so the tie's head is next to the rope.



STEP 8

Wrap a fifth cable tie around the VR2W receiver and the rope so the cable tie occupies the bottom half of the groove used in Step 7. Latch the cable tie so the head of the cable tie is over the rope.



STEP 9

Trim the cable ties so there is no excess cable tie material and no sharp edges.



5 Maintenance

5.1 Battery Replacement

Replacing a battery in the VR2W requires four basic steps:

1. Opening the case (section 2.1)
2. Removing the battery
3. Inserting the battery (section 2.2)
4. Closing the case (section 2.3)

Most of these topics were covered when we first setup the receiver. The only remaining topic to cover is how to disconnect and remove the battery.

5.1.1 Disconnecting and Removing Battery

STEP 1

Open the case as explained in section 2.1 and set the Outer Cylinder aside.



STEP 2

Press the release lever on the battery connector and pull the connector apart. The connector is small and a small flat screw driver may be helpful.



STEP 3

Remove the O-ring from around the end of the battery section of the receiver.

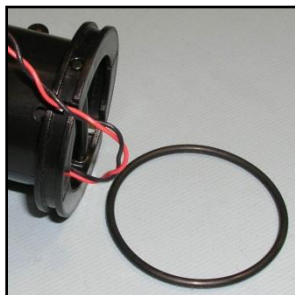

STEP 4

Slide the pin along its long axis until it exits the receiver case.

TIP: Apply pressure (see arrow) on the battery end while pushing pin forwards.



STEP 5

Slide battery out of case and dispose of it according to local regulations.



5.2 O-ring Care

O-rings located in the end-cap of the VR2W case are crucial to the watertight seal of the receiver. Each time an O-ring is disturbed, for any reason, it **must** be checked before the unit is sealed again. Something as simple as a stray hair could be the difference between a successful study and a damaged receiver.

Just as the O-rings are vital to a good seal, so are the O-ring surfaces. These surfaces hold the O-ring in position and must also be clean and damage free or the VR2W case could flood with water.



Improper care of the O-rings and their mating surfaces can result in water leaking into the receiver casing, destroying the electronics.



Each time an O-ring is disturbed, for any reason, it **must be checked** before the unit is sealed again.

5.2.1 Remove O-rings

The O-rings must be removed from their grooves to allow the O-rings and the grooves to be inspected and cleaned. Don't use a sharp object, which may damage the groove surface, when removing the O-rings. **Always wear protective gloves when handling O-ring grease!**



Do not use a sharp object near O-ring surfaces. The surface could be damaged.

STEP 1

Use a lint-free cloth to grip two points on the O-ring with your thumb and finger, approximately 5 cm apart. It's best to start with the O-ring farthest from the case threads.

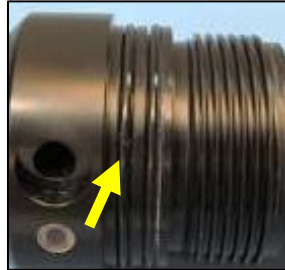

STEP 2

Pull your thumb and finger towards each other while maintaining your grip on the O-ring. This requires pressure against the O-ring and should produce a loop of exposed O-ring.



STEP 3

Grab the exposed O-ring and pull it away from the end cap, so it moves along the body of the receiver.



STEP 4

Repeat Steps 1 -3 for the other O-ring.

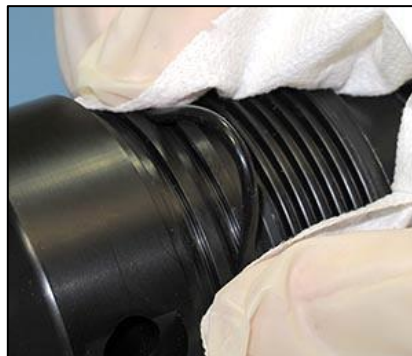

STEP 5

Clean any O-ring grease on the plastic casing.



5.2.2 Clean O-ring Surfaces

The O-ring surfaces must be clear of all debris and dirt. Any debris could cause water to enter the case and destroy the receiver.

An O-ring surface is any surface the O-ring touches. The VR2W has three, the two grooves the O-rings sit in and the smooth area inside the Outer Cylinder that sits between the threads and the end of the cylinder.

O-Ring Surfaces

An O-ring surface is any surface the O-ring touches. The VR2W has three, the two grooves between the threads and the LED on the end cap and the first flat section inside the Outer Cylinder (2 cm).

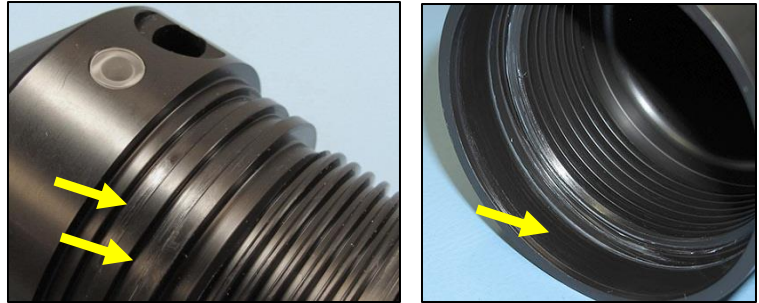

It is vital that all O-ring surfaces are clean and damage free or water may work its way inside the case and destroy the electronics within the VR2W receiver. **Always wear protective gloves when handling O-ring grease!**

STEP 1

Use a lint-free cloth to clean the old grease and any debris from the O-rings and the O-ring surfaces. A lint-free swab is very helpful for cleaning inside the grooves.



STEP 2

Inspect the O-ring surfaces for any scratches or debris – use a magnifying glass and a bright light. Scratches in the O-ring groove would allow water to bypass the O-ring, potentially flooding the receiver and destroying the internal electronics. If you find debris (dirt, dust, hair, etc) inside a groove, then use a lint-free swab to remove it. If you find a scratch in any of the O-ring surfaces, then contact our Support department.



STEP 3

Inspect the O-rings for debris and for any damage. If there is any question about the condition of an O-ring, we recommend it be replaced rather than risk damage to the receiver and therefore your data. O-rings can be purchased for VEMCO or locally. The replacement O-rings must be PARKER #2-143 O-RING, 70 Bn NITRILE.



CAUTION: O-rings can stretch with continued handling. We advise that undamaged O-rings not be used for more than three deployments.



STEP 4

Always wear protective gloves when handling O-ring grease! Use your gloved fingers to evenly spread O-ring grease (we suggest Molykote 55) over the entire surface of the O-ring until the O-ring is slippery but doesn't have clumps of grease on it. Too much grease can cause an O-ring to "pop" out of the groove while the case is being closed, giving little protection from water entering the VR2W.

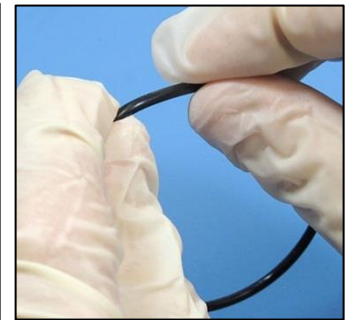

STEP 5

While you have grease on your glove, spread a very thin layer of the grease – enough to make the area appear shiny – around the O-ring surface on the inside of the Outer Cylinder (the smooth area between the threads and the end of the case). You shouldn't be able to see grease globs or streaks. This thin layer of grease will make screwing the two pieces together again much easier and will also help to create a better seal.

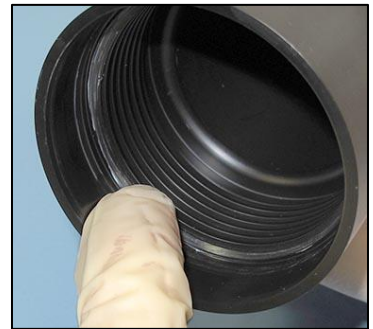

5.2.3 Install O-ring

Now that the O-rings and O-ring surfaces are clean and prepared, we're ready to install the new O-rings into the case. **Always wear protective gloves when handling O-ring grease!**

STEP 1

Slowly move one of the O-rings along the body of the VR2W to the end cap and carefully lift it over the threads.



STEP 2

Push the O-ring into the first O-ring groove and check the circumference of the receiver to make sure the entire O-ring is in the groove.

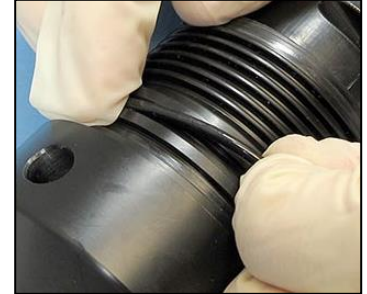

STEP 3

Slowly move the second O-ring over the VR2W's body, over the threads, and into the remaining groove. Check that it's entirely in the groove.



STEP 4

Clean any grease that may have gotten on the body of the receiver.



Place the receiver on a clean surface so the O-rings remain debris and damage free.

5.3 Storage

When a receiver will not be deployed for an extended period of time, remove the battery from the receiver (section 5.1.1) to stop the VR2W from recording. This will prevent the possibility of recording pings from noise sources during storage and also saves battery life.

Be sure to store the VR2W in a safe location where the case will not be damaged. Also be sure the temperature of the receiver during storage does not exceed the operating temperature specified in section 9.4.

It is strongly suggested that the VR2W is not initialized prior to storage (data is not erased) and a backup of all offloaded data is made immediately.

Put a fresh desiccant pack in the VR2W (see section 2.3) before placing it in storage to protect from humidity.

6 Additional Information

6.1 Flash Memory

The VR2W receiver uses a non-volatile Flash Memory (memory that can retain stored information even when not powered) to store valid detections of coded transmitters and the date/time at which the detection was recorded. The VR2W will not continue to record received data once the memory is full.

A VR2W receiver contains either 8 MB or 16 MB of memory depending on when it was manufactured. To know the memory capacity of your receiver, communicate with the receiver and check the “Memory Size” value in the receiver information.

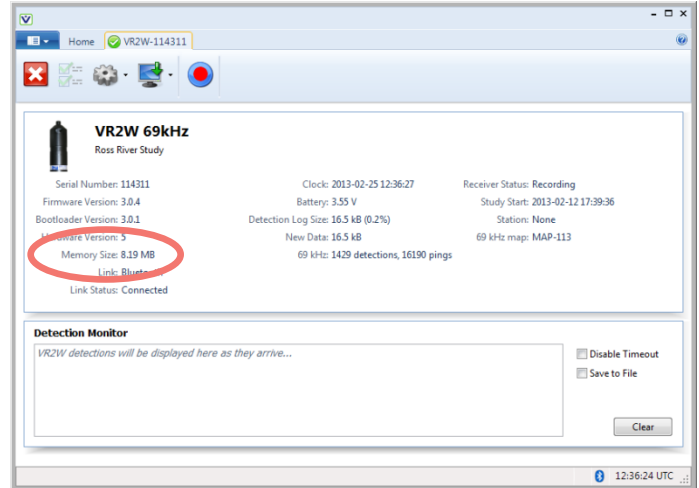

6.1.1 Time required to fill memory

A VR2W receiver with 8MB of memory is capable of storing more than 0.8 million valid detections while the 16 MB model can store more than 1.6 million detections. How long it takes to fill the memory depends on how frequently the data is received. For example, if a valid detection is received every 20 seconds then it will require approximately 365 days to fill the 16 MB VR2W memory. It will take less time if the detections are received more frequently, as illustrated in the table below.

Time required to fill VR2W memory based on various detection time.		
Valid detection every...	Time to fill 8 MB memory	Time to fill 16 MB memory
10 Sec	3 months	6 months
20 Sec	6 months	12 months*
30 Sec	9 months*	18 months**
40 Sec	12 months*	24 months**
50 Sec	15 months*	30 months**
60 Sec	18 months**	36 months**

* Exceeds battery life of the VR2W-180kHz receiver

** Exceeds battery life of both the VR2W-69kHz and the VR2W-180kHz receivers

6.1.2 Time required to offload memory

The time required to offload the data from a VR2W depends on how much data is stored in the memory. Table 6-2 below lists the approximate times required to offload data from a VR2W based on the amount of data stored in memory. These times are approximations only – actual offload times can vary on a number of factors, including the distance between the receiver and PC, the number of connected Bluetooth devices, and any obstacles between the receiver and the PC that can cause interference. Offload times can also vary if a Vemco-supplied Bluetooth dongle is not being used (i.e. built-in Bluetooth radios in laptops).

Time required offloading data from VR2W to PC based on various amounts of data.	
Amount of Memory Used (MB)	Time to offload from VR2W (minutes)
1	1.6
2	3.3
4	6.6
6	9.8

6.2 Status Light Flashes

The Status Light (LED) on the side of the VR2W case flashes based on the task being performed or the status of the receiver. The flashes can be interpreted using the table below. The Status Light is an LED (Light Emitting Diode) and has been referred to as such in past documentation.

Status Light Flash (LED) meanings	
VR2W LED Flashes	Interpretation of Flashes
No flash	Battery is disconnected or has depleted
Two quick flashes every 5 seconds	VR2W is in record mode (records any received pings)
Two quick flashes every 10 seconds	The VR2W memory full
One short flash	An acoustic ping was received
One long flash	A complete detection was written to memory
Continuous long flashes (1 per second)	The VR2W is ready for <i>Bluetooth</i> wireless technology communication
LED on constantly	Communicating with VUE software using <i>Bluetooth</i> wireless technology

When the VR2W is first powered, it will flash four times to indicate that it has successfully completed the start-up process. After the four flashes, the Status Light will begin flashing based on its status. The most

common flash pattern is two quick flashes every 5 seconds to indicate the receiver is recording. If the receiver's Status Light flashes anything other than what is explained in this section, then contact VEMCO's Customer Support team for assistance.

6.3 Set Local options

The local options feature (icon shown at right) allows you to change which suppressed pop-up queries are visible. This feature is only enabled on the ribbon if there are queries that have been suppressed. To enable a query, select "Always Ask" and that query will be enabled the next time that feature is used. For example, if "Confirm before closing VR2W" is selected, then a query will open the next time a VR2W is closed.

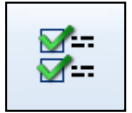

Changing an action is also possible in the Control Setting window, without enabling the query. For example, if "No" was selected when the "Import offloaded files into database" was disabled and you now want to import the data without being queried each time, then click the drop-down menu next to the answer and select "Yes" from the list.

Be sure to select "OK" to apply the changes.

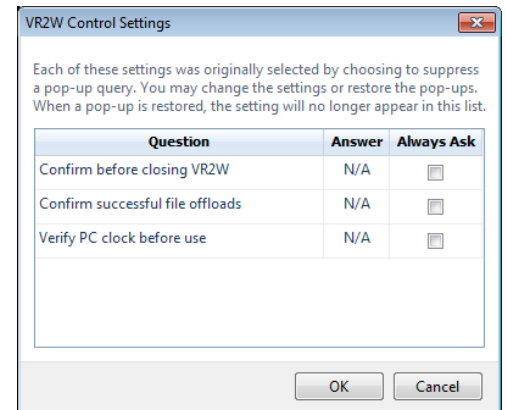

6.4 Battery

The VR2W receiver is powered by a single “D” size 3.6 Volt Lithium battery with a connector attached – the Tadiran TL-5930/F. Specifications for the Tadiran battery are found in section 9.4 (Appendix). Other battery options, including a non-dangerous goods battery option, are available directly from VEMCO. Contact VEMCO if you are interested in more information on these alternatives.



An important feature of the approved lithium batteries is their voltage discharge characteristics. These batteries provide a consistent voltage for most of the life of the battery, as demonstrated with the blue line in the graph below. This characteristic allows the receiver to operate at the necessary voltage levels longer than a battery with a more gradual voltage fall-off. This can be seen by comparing when the blue and green lines in the graph below cross the red “cut-off voltage” line.

As the graph illustrates, the battery voltage reported by a receiver may be at the correct level for proper operation even when the battery is close to the end of its life. The voltage value reported by a VR2W indicates the battery is at the proper voltage at the moment but does not give any indication of the remaining life of the battery. For that reason, we suggest you write the date on the battery when it is installed in the receiver.

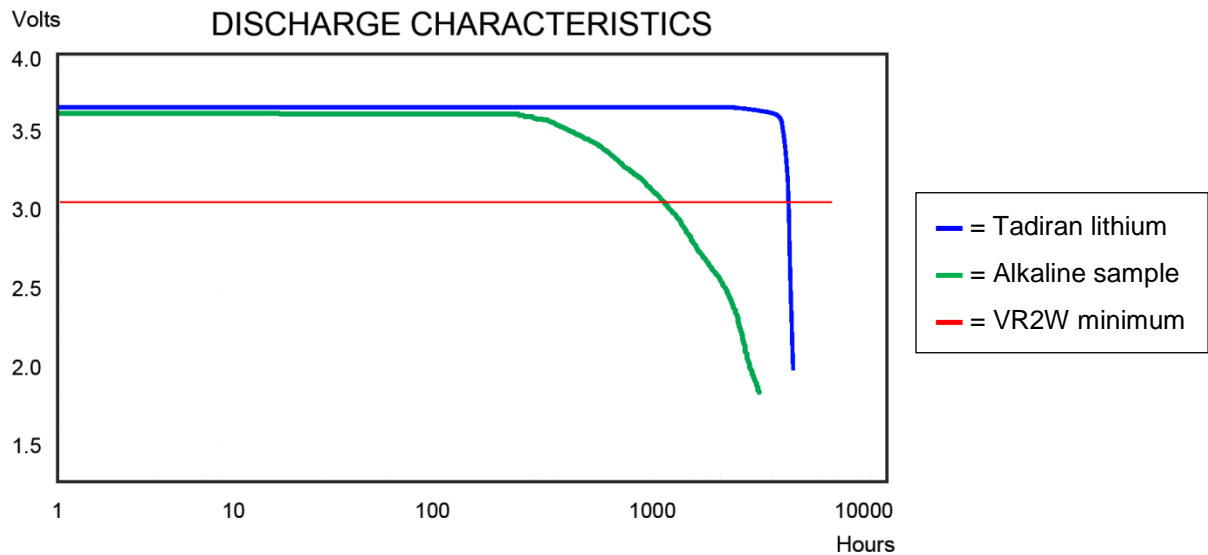

The VR2W is usually shipped with the battery inside the VR2W but not connected – the VR2W is not shipped powered. Battery life is consumed from the time the battery is connected so always disconnect the battery when the receiver is not being used for an extended period of time. The battery must be connected before the VR2W can be initialized.



Lithium metal D-cell batteries are classified as **Dangerous Goods** and must be handled according to UN Recommendations on the Transport of Dangerous Goods (UN3090 for batteries alone; UN3091 for batteries contained in equipment or packed with it). See the MSDS from the battery company for more information.

6.4.1 Battery Life

A new Lithium D-cell battery (complying to the specs listed in section 9.4) will typically last 15 months in a VR2W-69kHz and 8 months in a VR2W-180kHz receiver.

Typical Battery Life Consumption

VR2W-69kHz = 15 months
VR2W-180kHz = 8 months

Larger amounts of battery life are consumed while the VR2W is ready for *Bluetooth* communication or is communicating with the PC than during the receiver’s Record mode. For this reason, the VR2W exits *Bluetooth* mode as soon as the Receiver tab in the VUE software is closed (section 3.6.1). If the tab is left open for 30 minutes, the PC will automatically terminate the *Bluetooth* link and the receiver will enter the lower power consuming Record mode. This auto-disconnect feature, which conserves battery life, will only occur if “Automatically close inactive receiver connections” is enabled in the *Devices* section (tab) of the *Options* window in VUE (see VUE manual for details).

If the study is not continuing (i.e. the last download of data for this study has occurred), then remove the battery and store it separately. The used battery may be marked with the amount of life used for future reference or use.

NOTE

Battery life is consumed from the time the battery is **installed**, even if the VR2W is not detecting tags.

NOTE

Always remove the battery when the receiver is not being used for an extended period of time.

6.5 Case External Dimensions

The dimensions of the VR2W case can be useful when designing a mooring plan or mooring equipment. The dimensions, in inches, of the two case types are shown in the drawings below.

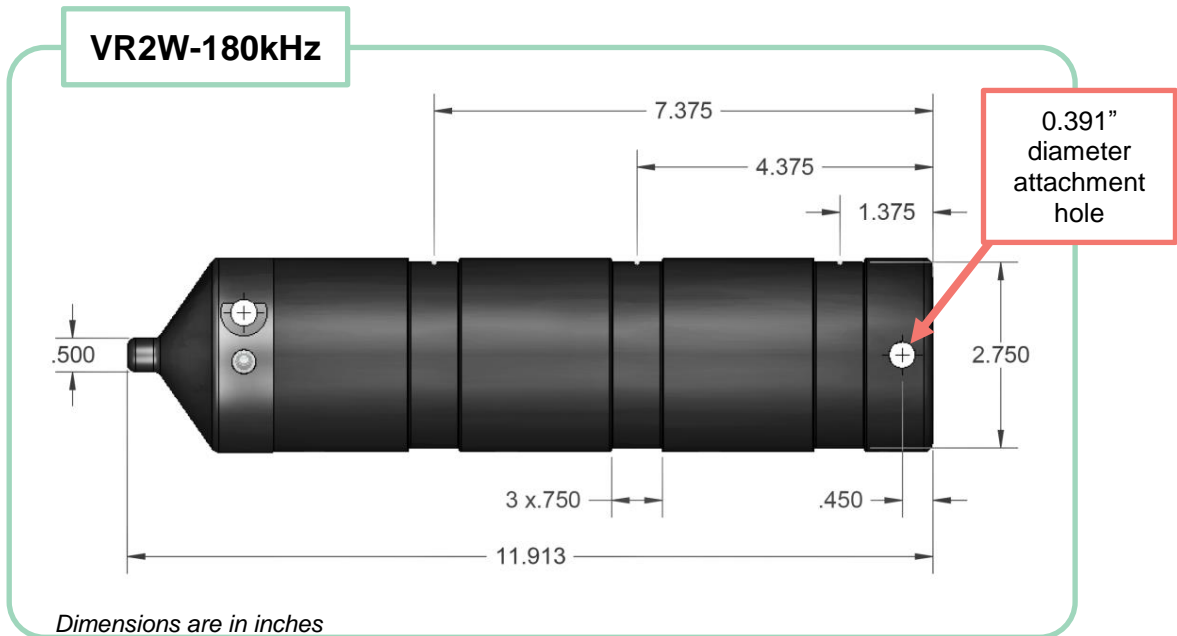
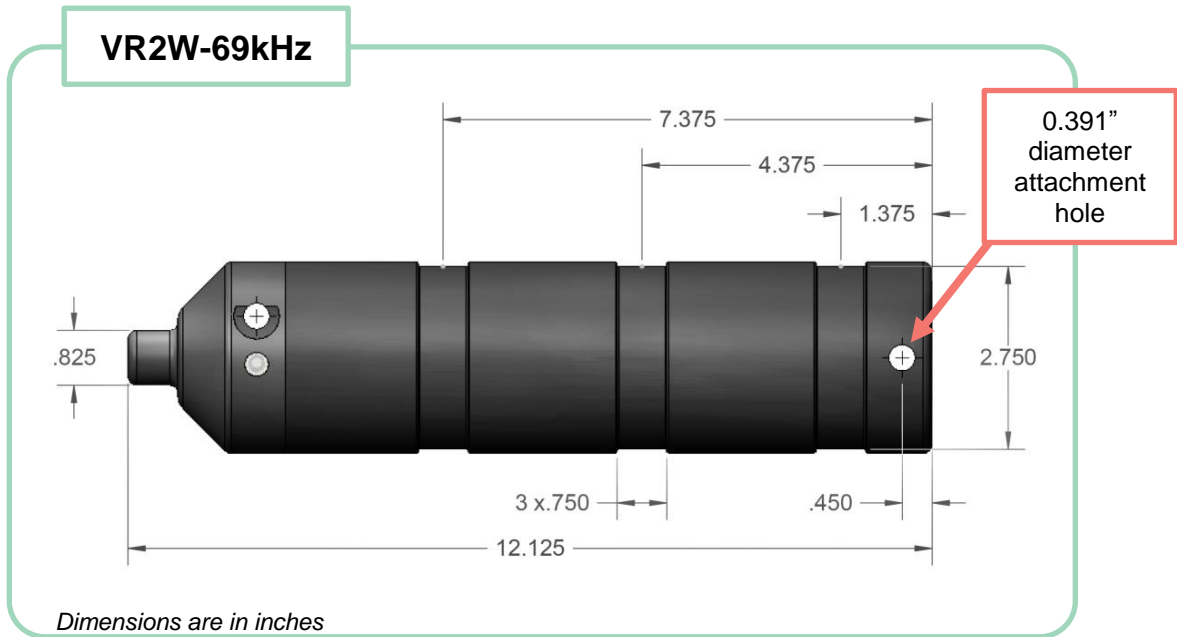

6.6 Update Firmware

Firmware refers to the internal software that operates a VR2W receiver. It is not to be confused with VUE, the PC software used to communicate with the receiver. Firmware updates are rare and will occur to either deal with a hardware change or occasionally for a significant addition to functionality. VUE 2.0.10 and greater has the ability to alert you if there is a new firmware update (feature can be disabled in the “Releases” tab of the Options window).

How to Update Firmware Using Automated Notification:

If when you establish communication with the VR2W (see section 3.3 in the VR2W user manual) you receive a message indicating VUE has detected there is a firmware update, then use the instructions below to update your firmware. To learn what caused the firmware upgrade, use the “Click here to see more” option in the notice window.

STEP 1

Decide if this is the right time to update the VR2W firmware by answering the following questions:

1. Does the VR2W's battery have enough power to perform an update? If there is any doubt, then replace the battery before proceeding. **The VR2W could be damaged if power fails during the update.**

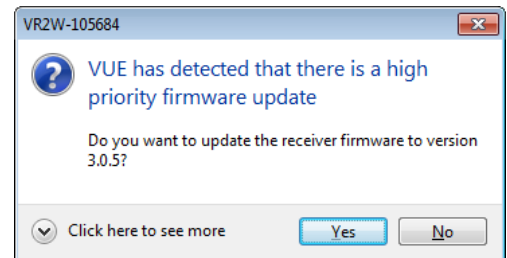

2. Has all the data been offloaded from the VR2W? If you are updating from a firmware version older than 3.0, then all the data in the receiver will be erased. Updating from a version more recent than 3.0 should not erase the data, but please take the precaution of offloading all data before updating.

If you answered “No” to either of these questions, then click the “No” button in the notice window and either replace the battery (see section 5.1 in the VR2W user manual) or offload the data (see section 3.5 in the VR2W user manual), or both if necessary. The notice window will appear again the next time you connect to this VR2W, or use the instructions for manually updating the firmware found in the next section.

If you answered “Yes” to both of these questions, then click the “Yes” button and continue with these instructions.

STEP 2

Assuming all data has been offloaded from the VR2W and is safely stored on your PC, click “OK” to acknowledge this warning and continue.

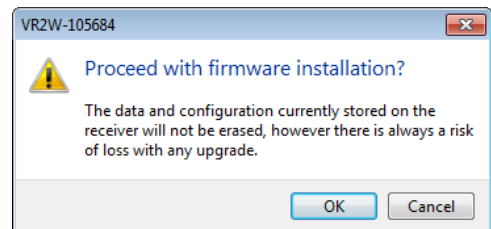

Continued...

STEP 3

Verify that the Bluetooth activation key is still in the receiver, or place it in the receiver if it had been removed. This is important as the VR2W will require it to be in place to re-establish communication during the procedure.

Keep Bluetooth Activation Key in VR2W.

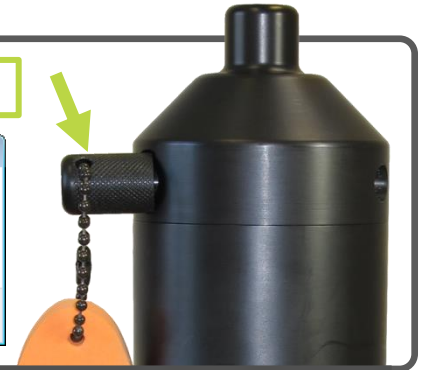
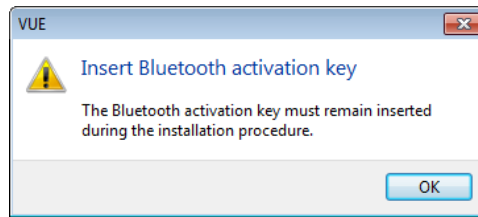

STEP 4

Wait while the firmware is loaded into the VR2W. The status of the update is shown at the bottom of the screen. Click "OK" when the firmware is installed (see below).

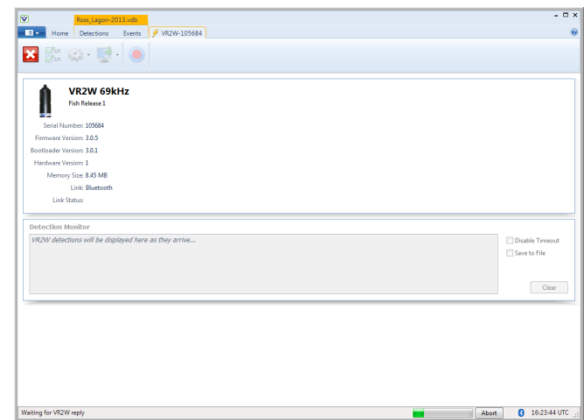
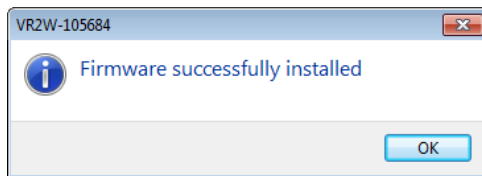

STEP 5

Confirm that the VR2W has updated to the new firmware by checking that the firmware version number listed in the Receiver tab is correct.



How to Update Firmware Using Manual Procedure:

If the automatic notification doesn't appear, then you can manually update the firmware. Contact support.team@vemco.com for detailed instructions.

6.7 Map Updating

Occasionally, VEMCO releases a new coded map. Updating the map in the VR2W is as simple as starting a new study with the new map selected. Follow the basic steps below to start a study with the new map. More details on how to initialize the receiver is found in section 3.5.1.

WARNING

Setting up a receiver with an incorrect map may result in no detection data.

1. Download the latest VUE software from www.vemco.com/downloads/.

2. Communicate with the VR2W receiver (sections 3.3 and 3.4).

3. Click the red and blue “Start Recording” button found in the receiver tab’s ribbon. If you have more than one receiver connected to VUE, then make sure you have the tab of the desired receiver selected.

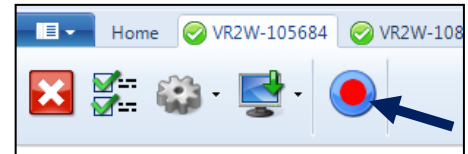

4. Verify that the PC clock is correct. The receiver will be set to UTC time based on the current time of the PC. The PC time *and the UTC offset* must be correct.



It is vital that the PC clock be correctly set to your local time, including time zone, **before the VR2W is initialized**.

5. Select to erase the old data and begin the study – only select this option if the data has already been offloaded to the computer.



Retrieve all detection logs **before** the VR2W is initialized; receiver’s memory will be erased.

6. Select “Show Advanced Settings” in the Study Configuration window.

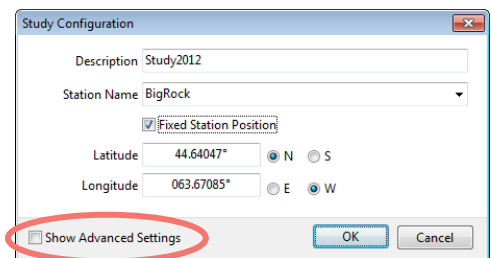

- Click on the down-arrow to the right of the Map name and select the new map.
- Click the “OK” button to begin the study.

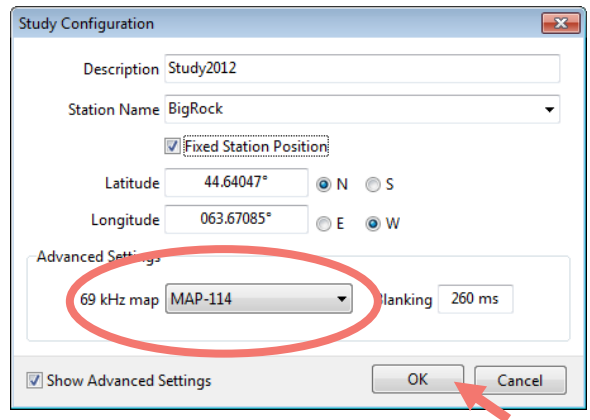
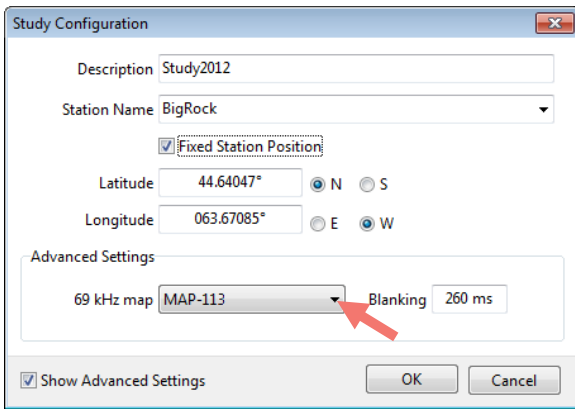

- Verify that the Status light on the VR2W is flashing two quick flashes every five seconds.
- Verify that the map listed in the receiver information is the new map you selected.



VR2W 69kHz

Test VR2W

Serial Number: 105684	Clock: 2012-02-10 17:13:05	Receiver Status: Recording
Firmware Version: 3.0.3	Battery: 3.44 V	Study Start: 2012-01-23 17:08:16
Bootloader Version: 3.0.1	Detection Log Size: 144 Bytes (0.0%)	Station: BigRock
Hardware Version: 1	New Data: 144 Bytes	Position: 44.64047-063.67085
Memory Size: 8.45 MB	69 kHz: 18 detections, 303 pings	69 kHz map: MAP-114
Link: Bluetooth		
Link Status: Connected		

- Close the communication connection with the VR2W by clicking the red box with the white “X” (Close View) on the left side of the receiver ribbon.

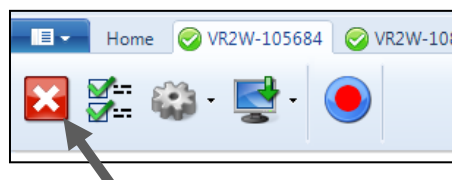

7 Common Questions

7.1 VUE related questions

7.1.1 How/when do I change my receiver code map?

Receivers must be configured with a Code Map that defines which type of tags the receiver can detect. Check www.vemco.com for details on currently supported Code Maps and choosing the proper map for your study.

Changing a receiver map is not done often and should be done with careful attention. Setting up a receiver with an incorrect map may result in no detection data, which would not be discovered until you retrieve the receiver and offload your data.

WARNING

Setting up a receiver with an incorrect map may result in no detection data.

When a receiver is configured with a new map, the data logs are automatically erased as they are no longer valid in the presence of a different code map. Please offload stored data prior to installing a new code map.

Detailed instructions on configuring your receiver with a new code map are located in section 6.7.

7.1.2 What is initialization?

Initialization, which is also referred to as starting a study, is an important step required to configure your receiver correctly. During initialization, you can input the station name (location) where the VR2W will be deployed and set the receiver clock based on your computer clock. The receiver clock is always updated based on your PC clock during the initialization process. This information will be resident with the VR2W and will be available during offload, regardless of whether you use the same computer or not. Initialization also erases the receiver log files so be sure to offload data from your receiver *before* initializing it. When data is offloaded from a receiver, the VRL file created contains information about how the receiver was initialized.

WARNING

Offload your data first!
Initializing a receiver will ERASE all data!

If a VR2W receiver is deployed without being initialized, the receiver will detect tags but the receiver will not necessarily have the correct clock setting or map configuration required for proper data detection.

7.1.3 Why does VUE create two .vrl file types?

When a receiver is offloaded, VUE creates:

- a **detection file** (see “A” below) and
- an **RLD data file** (see “B” below).

Both files have the “.VRL” extension. The **RLD** data files have the letters “**RLD**” in the filename.

IMPORTANT: VUE only imports **detection VRL files** (e.g., VR2AR_545565_20141216_1.VRL). You cannot import **RLD** files (it will cause errors).

Name	Date modified	Type
VR2AR_545565_20141216_1.vrl	12/16/2014 12:18 ...	VRL File
VR2AR_545565_20141216_2.vrl	12/16/2014 3:09 PM	VRL File
VR2AR_545565_20150210_1.vrl	2/10/2015 3:07 PM	VRL File
VR2AR_545569_20140814_1.vrl	8/14/2014 2:21 PM	VRL File
VR2AR-RLD_545565_20141216_1.vrl	12/16/2014 12:20 ...	VRL File
VR2AR-RLD_545565_20141216_2.vrl	12/16/2014 3:10 PM	VRL File
VR2AR-RLD_545565_20150210_1.vrl	2/10/2015 3:09 PM	VRL File
VR2AR-RLD_545569_20140814_1.vrl	8/14/2014 2:21 PM	VRL File
VR2C69_450000_20130412_1.vrl	4/12/2013 1:40 PM	VRL File
VR2C69_450000_20130412_2.vrl	4/12/2013 1:44 PM	VRL File

The **RLD** data file (VR2AR-**RLD**_545565_20141216_1.VRL) is only used by VEMCO for diagnostic purposes, and should be archived in case it is required by our Support Department.

7.1.4 What Date/Time format is my data stored in the receiver and displayed in VUE?

All detection data and events are stored in the receiver in UTC (Coordinated Universal Time). UTC time is calculated by your PC and stored in your receiver during initialization. Provided your computer time and the Time Zone settings are correct and match, i.e. your computer time is correct for the time zone you have selected, then your detection data will be stored in the correct UTC format at the time of initialization and data offload.

In VUE, your data is also stored in UTC format in the database. You can choose to display your detections in UTC, your local time or in a different time zone. It is important to know that regardless of whatever display format you choose VUE maintains the detection data in UTC.

Export: All detection data is exported only in UTC unless specified otherwise in VUE by selecting OPTIONS – EXPORT – CUSTOM

Important: If you are importing detection data from an older format detection file (e.g., VR2*.000) you must specify the time zone offset used when the receiver was initialized. Earlier VR2 receivers were most often initialized with the current PC local time unless the PC local time was set to UTC. Please contact us if you need assistance. Once these older files are imported into VUE, a new .vrl file will be created and all timestamps will be in UTC.

7.1.5 What does the “Hide this (window) in future” mean?

There are a number of pop-up windows that appear while using the VUE software. These windows are wonderful when you’re just learning the software or when you’ve been away from it for an extended period of time, but they can be very annoying when you’re in the middle of a big study. A number of these pop-up windows have a selection box in the bottom left corner that say something along the lines of “Hide this alert in future.” Selecting this option

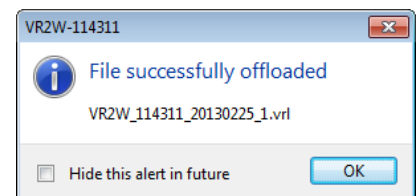

means that this window will not appear the next time the task is performed. The pop-up windows can be returned by altering the local options or selecting “Restore All Hidden Dialogs” in the *Options* window (see section 6.3). All hidden dialogs are restored automatically if one week elapses without VUE being opened.

7.1.6 How do I open the *Options* window?

The *Options* window is accessed by selecting the *VUE* menu (circled in picture at right) and clicking the “Options” button at the bottom of the menu box (see arrow in picture at right). The *Options* window contains the following tabs: Display, Offload, Export, Devices, and Other. These are described in detail in the VUE manual.

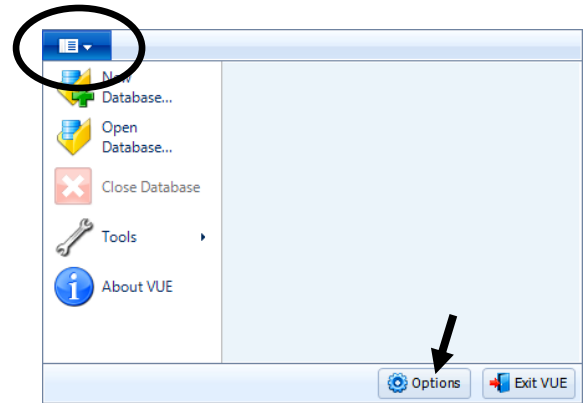

7.2 VR2W related questions

7.2.1 How much detection range can I expect from my tags and receivers?

Detection range depends on so many factors that it is difficult to estimate without knowledge of the environment and prior experience with telemetry. Range depends on transmission power, signal absorption, line of sight, reflection/refraction, multipath and environmental noise (man-made & natural), and the receiving quality of the receiver/hydrophone. Typically areas that have clear water, sand or silt flat bottoms and low current exhibit the greatest ranges. Conversely, areas with turbid water, complex rocky bottom topography and high current exhibit low ranges. In all cases, extreme weather events and periods of high wind (waves) may significantly reduce range.

In most cases greater transmission power output (dB) results in greater range. For example, in good conditions a V7-VR2W range test could yield a range of 300-400 m and a V16-VR2W test could yield ranges of 800-1200 m. There are some exceptions where high power and a reflective and low noise environment may cause detection breakdowns.

Please try our range calculator at www.vemco.com/customer-service/?cs-tutorials, but only use the results as a guide. One should always perform range testing to determine appropriate receiver spacing. For the enthusiast who wants to learn more about sound propagation try the widely accepted reference on underwater sound by Urick (1983). (Urick, Robert J. Principles of Underwater Sound, 3rd Edition. New York. McGraw-Hill, 1983.).

7.2.2 How long will my VR2W battery last?

The VR2W-69kHz receiver will typically last 15 months on a single, new Tadiran lithium battery (model TL-5930/F). The VR2W-180kHz receiver will typically last 8 months.

TIP: Write the installation date on the battery so you know how long the battery has been in use.

7.2.3 Does receiver orientation matter?

Generally, in most cases we recommend that a VR2W should be orientated with the hydrophone looking upwards. This is typically because receivers are commonly moored closer to the seafloor than the surface. In some situations it may be beneficial to mount the receiver with the hydrophone pointing towards the sea floor. If a receiver is mounted near the surface or a considerable distance from the sea floor and if the researcher is monitoring benthic creatures a bottom looking receiver may perform better because your tagged animals will not be in a shadow zone (under the receiver). If receiver orientation is a concern we recommend that you perform range tests using both orientations.

7.2.4 At low tide my VR2W receiver will be exposed to direct sunlight, does this matter?

The VR2W receiver has a recommended operating temperature of between -5 to 40°C. If there is a chance that your receiver will exceed either of these temperatures please consider another location for the receiver. Keep in mind that direct sunlight on the black case can cause the receiver's internal temperature to be much higher than the ambient temperature.

8 Troubleshooting

8.1 VUE related troubleshooting

8.1.1 Bluetooth Troubleshooting

Instructions and tips for using Bluetooth with the VUE software can be found at <http://vemco.com/wp-content/uploads/2015/01/bluetooth-quick-guide.pdf>.

8.1.2 I cannot connect to my VR2W receiver

First confirm that your *Bluetooth* connection between VUE and your VR2W receiver is functional. If this *Bluetooth* connection is functioning correctly, try replacing the VR2W battery in the VR2W with a new battery. If you are still unable to communicate with the unit, please contact VEMCO to receive RMA information and send the unit back to VEMCO for assessment/repair.

8.1.3 These detected ID's don't belong to me

We would be very pleased to help connect you with the owners of any unknown IDs. Please send a list of the unknown ID's and all associated receiver .vrl files to the VEMCO support team. VEMCO will first review the data to identify false detections and provide you with a false detection report. Then we'll contact the tag owners for all the valid detections and request that they contact you directly. Please indicate if you are willing to release your email address.

8.2 VR2W case related troubleshooting

8.2.1 The threads have been damaged

It's very important that the threads on the end-cap are not dented or the outer cylinder will not thread onto the end-cap properly. If the threads on the end-cap are slightly dented, use a sharp knife, such as an X-Acto knife, to remove the deformed plastic until the sides of the thread are smooth and below the normal line of the thread. It is important that there is nothing sticking out of the thread to damage the thread on the outer cylinder or prevent the case from closing.

8.2.2 I think the case might be pressurized

When handled correctly, the VR2W pressure case and seal have a static depth rating of 500 meters (730 psi). If the receiver experiences a pressure greater than this, then water may enter the case. NOTE: Physical shocks to the receiver, such as bumping into a solid object, when it is at any depth can result in a considerably higher pressure on the casing than just the depth pressure. Also, if the O-rings or their mating surfaces are dirty or damaged, then water may enter the receiver case.

If water enters the receiver case under high pressure and the Release Valve was unable to open and equalize the pressures, then some water and compressed air may still be in the case when it is returned to the surface. This can be identified by its increased weight and a sloshing sound when the case is moved. The VR2W case will also be very difficult to open, if at all possible. If you are suspicious there is compressed air in the receiver case, then check for air or water leaking from seam in the case where the end-cap and outer cylinder meet.

To check for...	then...
water leakage	dry the seam completely and watch for drops of water around the seam
air leakage	spread soapy water around the seam and watch for bubbles indicating air escaping

If air and/or water are found leaking from the receiver case, do not attempt to remove the end-cap. Instead, place the receiver in a safe place and cover it with a protective layer of towels, tarpaulins, etc. until the leaking stops. If water is still in the case after the air and/or water have finished leaking from the case, then attempt to open the case with the steel rod kit. If it will open, do so very slowly to allow the compressed air to escape. If the case will not open using the steel rods, then it is under a greater pressure than will allow the case to open. Contact VEMCO for further instructions.



When the pressure has been released from the VR2W case, carefully unscrew the end-cap from the outer cylinder (section 2.1). Use fresh water to rinse the internal parts of the VR2W while avoiding skin contact with any battery electrolyte that may have escaped from the battery.

Do not attempt to re-use the VR2W receiver after water has been inside the case. The internal casing protecting the electronics is not waterproof and the electronics have been destroyed by contact with water.

9 Appendix

9.1 VR2W Metal/PVC Casing

The VR2W receiver is housed in a black plastic high pressure case as shown in the photo below. The outer cylinder is removed from the receiver to install the D-cell Lithium battery, revealing the internal casing protecting the electronics. The older black VR2W receivers have a metal/PVC internal casing, which is explained in this document. The metal/PVC internal casing has an O-ring between the metal internal casing and the PVC battery cup to reduce vibration and is not used for water protection. Do not grease this O-ring.

The procedure for opening a black VR2W is the same regardless of the type of internal casing so we will begin with an open VR2W, shown below. Details on how to open the receiver are found in section 2.1.



WARNING

The internal casing surrounding the electronics is not waterproof. Water, even condensation from a humid environment, will enter the case and damage the electronics.

Remove Battery

1. Press the release lever on the battery connector and pull the connector apart. The connector is small and a small flat screw driver may help release the lever.
2. Press the back of the battery towards the body of the VR2W until the battery is not pressing against the O-ring. There is a spring at the other end of the battery cup so the battery will move.
3. Slip the O-ring from its groove as shown in the photo. The O-ring's purpose is to hold the battery from sliding out the end of the battery cup.
4. Slide the O-ring along the battery's connector wires so they are separated from each other.
5. Tip the VR2W so the battery slides out of the battery cup.



Insert Battery

1. Remove the O-ring from the groove in the battery cup if it hasn't already been removed.
2. Slide the wire-free end of the new battery into the battery cup. The connector wires should stick out the battery cup.
3. Thread the connector wires through the O-ring.
4. Press on the battery until the end of the battery is below the O-ring groove.
5. Squeeze the O-ring into an oval shape and push it into the groove in the battery cup as shown in the photo. **Do not grease this O-ring.**
6. Make sure the connector wires are not pinched in any way, especially between the O-ring and the battery or case. Pinched wires can break internally and disrupt power to the receiver.
7. Connect the Tadiran TL-5930/F battery to the VR2W connector in the proper orientation. The two connector halves should lock together with a little click.



Close the VR2W Case

The procedure for closing the VR2W with metal/PVC internal casing is very similar to the procedure with a plastic internal casing. The only difference is the placement of the desiccant pack. That difference is covered here but the rest of the steps required to close the case are found in section 2.3.

1. Position the battery wire so it's away from the end of the battery cup as shown in the photo (at right).
2. Hold the receiver's inner casing so the hydrophone is pointing down.
3. Place a new desiccant pack on top of the battery compartment and fold the ends of the pack over onto itself.
4. Fold the battery wires over so they are lying on top of the desiccant pack. This is important to protect the wires from being pinched inside the tube.
5. Slide the cylinder down over the inner casing until the first threads are inside the outer cylinder.
6. Turn the end-cap in a counter-clockwise direction with your hand until it becomes too hard to turn.



Battery wires



Desiccant pack in place



Sliding tube over inner casing



Hand tightening the case

A desiccant pack has been included in the bottom of the VR2W to reduce the occurrence of condensation in the VR2W. This pack should remain in the receiver case during storage and deployment.

We recommend that you replace the desiccant pack with each deployment and with each battery replacement cycle.

More information on the availability and usage of these packs is located at www.vemco.com.



9.2 Cleaning Instructions

Clean the VR2W with a damp cloth and mild detergent. Do not use solvents. Do not use a scraper or abrasive cleaner on the LED window or the seal surfaces.

9.3 Contact Information

VEMCO

20 Angus Morton Drive
Bedford, Nova Scotia
Canada B4B 0L9

Phone: +1-902-450-1700
Fax: +1-902-450-1704

Web Site: www.vemco.com



9.4 VR2W Specifications

Dimensions	308 mm (12.125") overall length x 73 mm (2.875") diameter		
Weight	1190 g in air; 50 g in water		
Receive Frequency	VR2W-69kHz: 69.0 kHz		
	VR2W-180kHz: 180.0 kHz		
Operating temperature	-5°C to +40 °C; Water in which VR2W is deployed <i>must not freeze</i> .		
Shipping & storage temperature	-5°C to +50°C		
Battery	1 - Tadiran TL-5930/F Lithium Inorganic battery or equivalent, 3.6 Volts <ul style="list-style-type: none"> • Nominal capacity @ 4 mA, to 2 V 19 Ah • Rated voltage 3.6 V • Maximum recommended continuous current 230 mA • Maximum pulse current capability 500 mA • Weight 105 g (3.7 oz) • Li metal content approx. 5 g U.L. Component Recognition, MH 12193		
Battery Life	VR2W-69kHz: Typically 15 months (using Tadiran TL-5930/F)		
	VR2W-180kHz: Approximately 8 months (using Tadiran TL-5930/F)		
Memory	VR2W-69kHz-110: 8 MB Flash memory (approx. 0.8 million detections)		
	VR2W-69kHz-111: 16 MB Flash memory (approx. 1.6 million detections)		
	VR2W-180kHz-110: 8 MB Flash memory (approx. 0.8 million detections)		
	VR2W-180kHz-111: 16 MB Flash memory (approx. 1.6 million detections)		
Static depth rating	500 meters (730 psi)		
Ingress Protection	IPX8 to rated depth		
<i>Bluetooth</i> wireless certifications	VR2W version:	Hardware ID < 6	Hardware ID ≥ 6
	Bluetooth ID:	B012394	D028756
	FCC ID:	ED9LMX9838	A8TBM78ABCDEFGH
	Industry Canada ID:	IC-1520A-LMX9838	12246A-BM78SPPS5M2
Attachment:	Standard method: 5 non-reusable lashing cable ties, 388 mm (15.25") long, 7.5 mm (0.3") wide, UV protected, 120 lb tensile strength (VEMCO number HWE 507450).		

WARNING



The VR2W pressure case and seal have a static depth rating of **500 meters** (730 psi). Physical shocks to the receiver, such as bumping into a solid object, when it is at any depth can result in a considerably higher pressure on the casing than just the depth pressure and water may enter the VR2W case. If the O-rings or their mating surfaces are dirty or damaged, then water may also enter the receiver case. If you are suspicious that water has entered the receiver, then follow the suggestions in the Appendix for troubleshooting a pressurized case.

9.5 Warranty and Disclaimer

AMIRIX Systems Inc. Warranty and Disclaimer

WARRANTY

AMIRIX Systems Inc., doing business under its trade name VEMCO, provides a one (1) year warranty period for the Product from date of shipment.

VEMCO warrants that on the date of shipment all Products manufactured by VEMCO are free from defects in material and workmanship under normal use and service. This warranty applies to the components necessary for equipment upgrades, i.e. the VR1/VR2 to VR2W upgrade. With respect to transmitter products, while VEMCO is able to predict battery life with some certainty, VEMCO cannot guarantee that these Products will remain functional while submerged for extended periods of time. This warranty does not apply to any equipment, materials or design supplied by Buyer or a third party; re-battery services provided by VEMCO; Products for which VEMCO has not received payment; problems that results from: external causes such as accident, abuse, misuse; servicing not authorized by VEMCO; usage not in accordance with Product instructions; failure to follow the Product instructions or failure to perform preventative maintenance; usage of accessories, parts or components not supplied by VEMCO.

This warranty shall survive delivery only on the conditions and subject to the limitations set forth below.

NOTICE PERIODS

To receive a warranty remedy for a Product, Buyer must contact VEMCO's Customer Support Department during the warranty period to receive the Return Material Authorization ("RMA") instructions. Each defective Product returned for warranty remedy must be shipped at the Buyer's expense according to the RMA instructions and must include reasonable proof that the claimed defect is due to a matter embraced within the warranty set forth above and that such defect did not result from any act or omission of Buyer, including but not limited to any failure to operate and maintain the Product in accordance with VEMCO's applicable written instructions.

REMEDY

VEMCO's liability, and the Buyer's exclusive remedy under this warranty, as to a defect in material or workmanship, is limited to the repair of such defect in the accessory, equipment or part in which the defect appears or, at VEMCO's option, to the replacement of such accessory, equipment or part with a similar item free from defect. As to any item repaired by VEMCO or furnished as a replacement by VEMCO, VEMCO's liability and the Buyer's exclusive remedy to the repair or replacement of such item for any further defect in material or workmanship, provided VEMCO receives written notice at Halifax, Nova Scotia, of such further defect from BUYER within ninety (90) days after the repaired or replaced item is shipped to BUYER and provided that BUYER returns same to VEMCO as provided under "Notice Periods".

RETURNED ITEMS

All repairs, replacements and corrections described above shall be performed by VEMCO at its plant at Halifax, Nova Scotia, or at such other place as may be mutually agreeable, and with reasonable care and dispatch in order that the Product, accessory, equipment or part will not be kept out of service longer than necessary. Return to BUYER of a repaired, replacement, or corrected accessory, equipment, part or Product shall be at VEMCO's expense. Title to and risk of loss of the Product, accessory, equipment, or part returned to VEMCO pursuant hereto shall at all times remain with the BUYER, except that title to a returned accessory, equipment, part, or Product shall pass to VEMCO concurrently with shipment to BUYER of any item furnished by VEMCO to BUYER as a replacement therefore. VEMCO shall have only such responsibility for any Product, accessory, equipment, or part owned by the BUYER and in the possession of VEMCO as is chargeable by law to a bailee for hire, but shall not be chargeable for loss of use thereof.

WEAR AND TEAR

Normal wear and tear and the need for regular maintenance shall not constitute a defect under this warranty.

DISCLAIMER AND RELEASE

THE WARRANTIES, OBLIGATIONS AND LIABILITIES OF VEMCO AND THE REMEDIES OF BUYER SET FORTH HEREIN ARE EXCLUSIVE AND IN SUBSTITUTION FOR, AND BUYER HEREBY WAIVES AND RENOUNCES, ALL OTHER WARRANTIES AND OBLIGATIONS OF VEMCO AND ANY ASSIGNEE OF VEMCO AND ALL RIGHTS, CLAIMS AND REMEDIES OF BUYER AGAINST VEMCO, EXPRESS OR IMPLIED, ARISING BY LAW OR OTHERWISE, WITH RESPECT TO ANY NON-PERFORMANCE OR DEFECT IN THE PRODUCT OR IN ANY OTHER THING DELIVERED UNDER THIS AGREEMENT, INCLUDING BUT NOT LIMITED TO:

- (A) ANY IMPLIED WARRANTY OF MERCHANTABILITY OR FITNESS FOR A PARTICULAR PURPOSE;
- (B) ANY IMPLIED WARRANTY ARISING OUT OF COURSE OF PERFORMANCE, COURSE OF DEALING OR USAGE OF TRADE;
- (C) ANY OBLIGATION, LIABILITY, CLAIM OR REMEDY IN TORT, WHETHER OR NOT ARISING FROM THE NEGLIGENCE OF VEMCO OR ANY ASSIGNEE OF VEMCO, ACTUAL OR IMPUTED;
- (D) ANY OBLIGATION, LIABILITY, RIGHT, CLAIM, OR REMEDY FOR LOSS OF OR DAMAGE TO THE PRODUCT, FOR LOSS OF USE, REVENUE, OR PROFIT WITH RESPECT TO THE PRODUCT; OR FOR ANY OTHER DIRECT, INCIDENTAL OR CONSEQUENTIAL DAMAGES; AND
- (E) VEMCO MAKES NO REPRESENTATION THAT THE PRODUCT WILL NOT INFRINGE ANY PATENT OR OTHER RIGHTS OF ANY PERSON AND BUYER AGREES TO INDEMNIFY VEMCO AND HOLD VEMCO HARMLESS FROM ANY AND ALL CLAIMS AND LIABILITIES WITH RESPECT TO SAME TOGETHER WITH ANY CLAIMS AND LIABILITIES WITH RESPECT TO ANY INFRINGEMENT OF ANY PATENT OR OTHER RIGHTS OF ANY PERSON ARISING AS A RESULT OF BUYER'S PRODUCTS, TECHNOLOGY, ACTIVITIES, OR OTHERWISE.

LICENSE AGREEMENT

VEMCO grants to the Buyer a limited, personal license, with no right to sub-license, to use the Intellectual Property ("IP") and Embedded Software in the manner set out in the Documentation. The Embedded Software and IP are not sold to Buyer. All property rights, including Intellectual Property Rights, remain with VEMCO. All rights related to the Embedded Software not expressly licensed to the Buyer are reserved to VEMCO. BUYER shall not permit any person other than BUYER and its employees to use or make use of the Embedded Software and/or IP. BUYER shall not, and shall not permit any third party to, modify, adapt, translate, reverse engineer, decompile, disassemble, or create derivative works based on the Embedded Software and/or IP. This license is assigned to the Product with which you have acquired the Embedded Software and/or IP. If the Product purchased is a Transmitter product, be advised that the license life is equal to the operational life.

EXPORT

Products and associated materials supplied or licensed hereunder may be subject to various export laws and regulations. It is the responsibility of BUYER to comply with such laws and regulations.

NEGOTIATED AGREEMENT

It is fully understood by the parties that the price of the Product and other mutual agreements of the parties set forth in this agreement were arrived at in consideration of this warranty, SPECIFICALLY INCLUDING THE WAIVER, RELEASE AND RENUNCIATION BY BUYER SET FORTH ABOVE (DISCLAIMER AND RELEASE).

9.6 Glossary

Bluetooth wireless technology: A technology based on the *Bluetooth* standard which provides for fast wireless communication in air, typically over a 10 meter range.

Bluetooth USB Adapter: This is a physical device that attaches to the PC USB port and enables your PC to communicate wirelessly to the VR2W receiver.

Code Map: Collection of code spaces that define the types of transmitters the receiver can detect.

Code Space: Nomenclature for VEMCO tags which provides unambiguous description of the coding parameters for that tag type.

Firmware: A computer program that is contained as a read-only memory in a hardware device. This program controls the hardware device and may be able to be upgraded, depending on the design of the product. The VR2W firmware can be upgraded if there is a design change.

MSDS/SDS: Material Safety Data Sheet/Safety Data Sheet are summary documents that provide information about the hazards of a product and advice about safety precautions. SDSs are usually written by the manufacturer or supplier of the product.

Offloading: Retrieving data from a VEMCO receiver and storing it in a VRL file.

Station Name: Name for a specific deployment location including lat and long parameters.

UTC: Co-ordinated Universal Time is a worldwide standard for time, sometimes referred to as Greenwich Mean Time. VUE configures VEMCO receivers in UTC time.

VRL files: Binary file format for VEMCO Receiver data logs read from VEMCO receivers.

VUE : VEMCO User Environment PC Receiver software from VEMCO.

VUE Database: A collection of imported VRL files. VRL files are all that is needed to recreate a database or to create other databases.

9.7 Index

- Battery, 32
 - Discharge, 32
 - Installing, 7
 - Life expectancy, 33
 - Replacement, 24
 - Specifications, 47
- Case
 - Closing, 9
 - External Dimensions, 34
 - Inside, 6
 - Introduction, 2
 - Opening, 4
 - Parts, 3
 - Visible differences, 2
- Code Map
 - When to change, 39
- Coded Map, 37
- Communication
 - Activate VR2W, 14
 - Bluetooth*, 12
 - Disconnect, 20
 - Establish, 15
- Deployment
 - Fact and Tips, 21
 - Mooring line attachment, 22
- Firmware, 35
- Initialization
 - What is it?, 39
- Memory
 - Flash, 29
 - Time to fill, 29
 - Time to offload, 30
- Options* window, 40
- O-rings
 - Cleaning surfaces, 26
 - Installing, 28
 - Removing, 25
- Quick VR2W facts, 1
- Record mode, 17
 - Indicator, 18
- Status Light (LED)
 - Flash meanings, 3, 30
- Storage, 28
- Testing
 - In-air, 11
 - In-water, 11
- Updating
 - Coded Map, 37
 - Firmware, 35
- VUE
 - Install software, 12
 - Local options, 31
 - Offload data, 19
 - Receiver Tab, 16
 - Start a Study, 17
 - Study Configuration, 18
 - Suppressed pop-up queries, 31
 - VRL file types, 39